

# **FYS1001**

# **Innføring i fysikk**

**Lasse Clausen**

**19.04.2021**

# Geometrisk optikk

beskrives vi lys som stråler

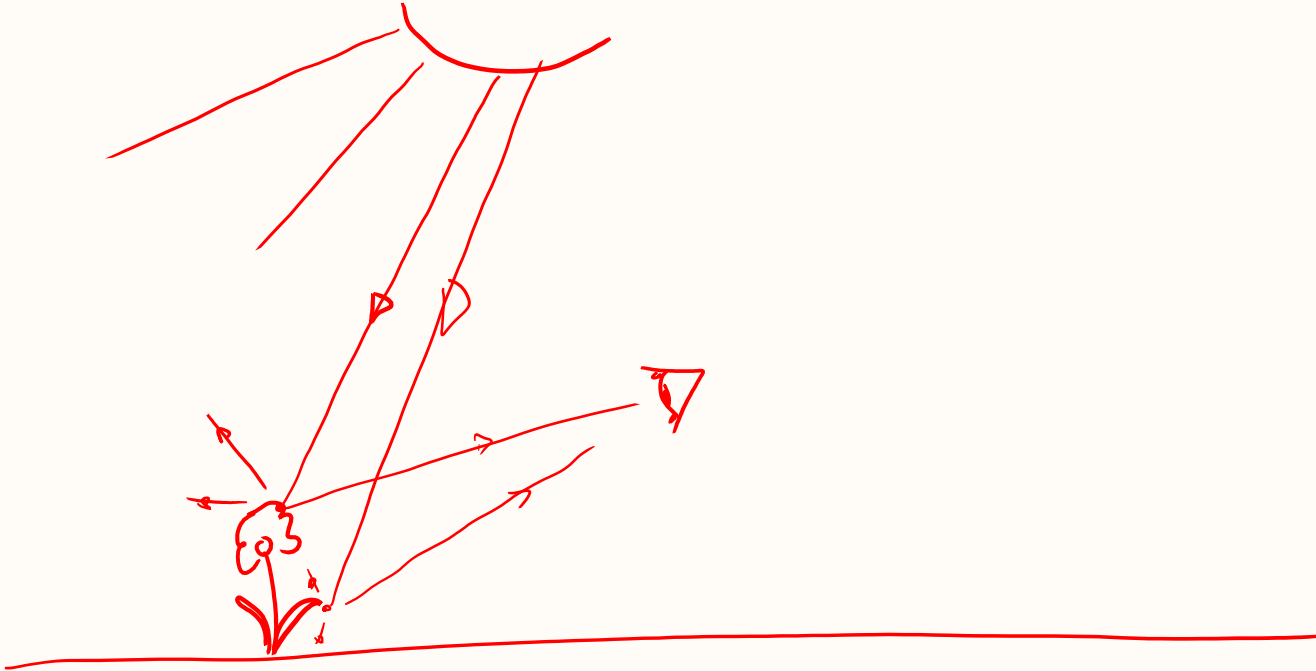

# Hullkamera

pinhole camera

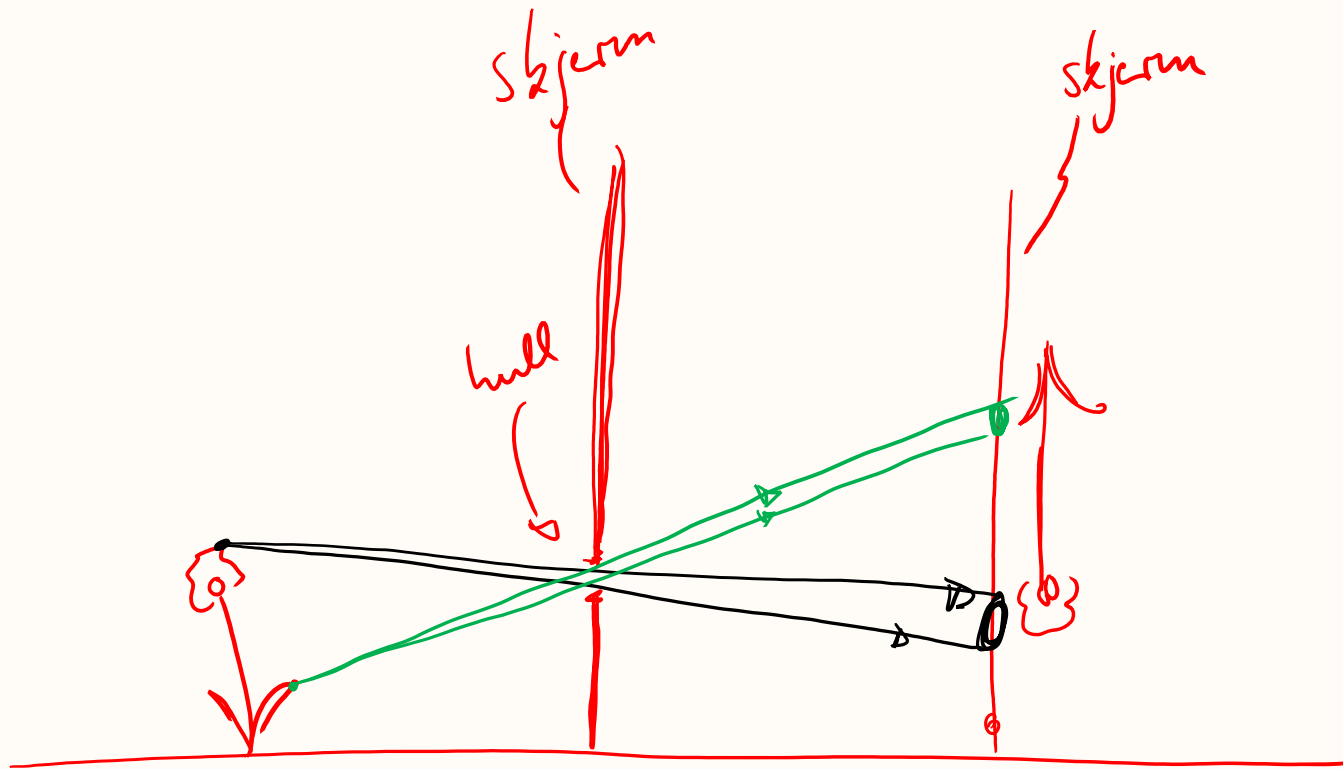

# Hullkamera



# Plan speil

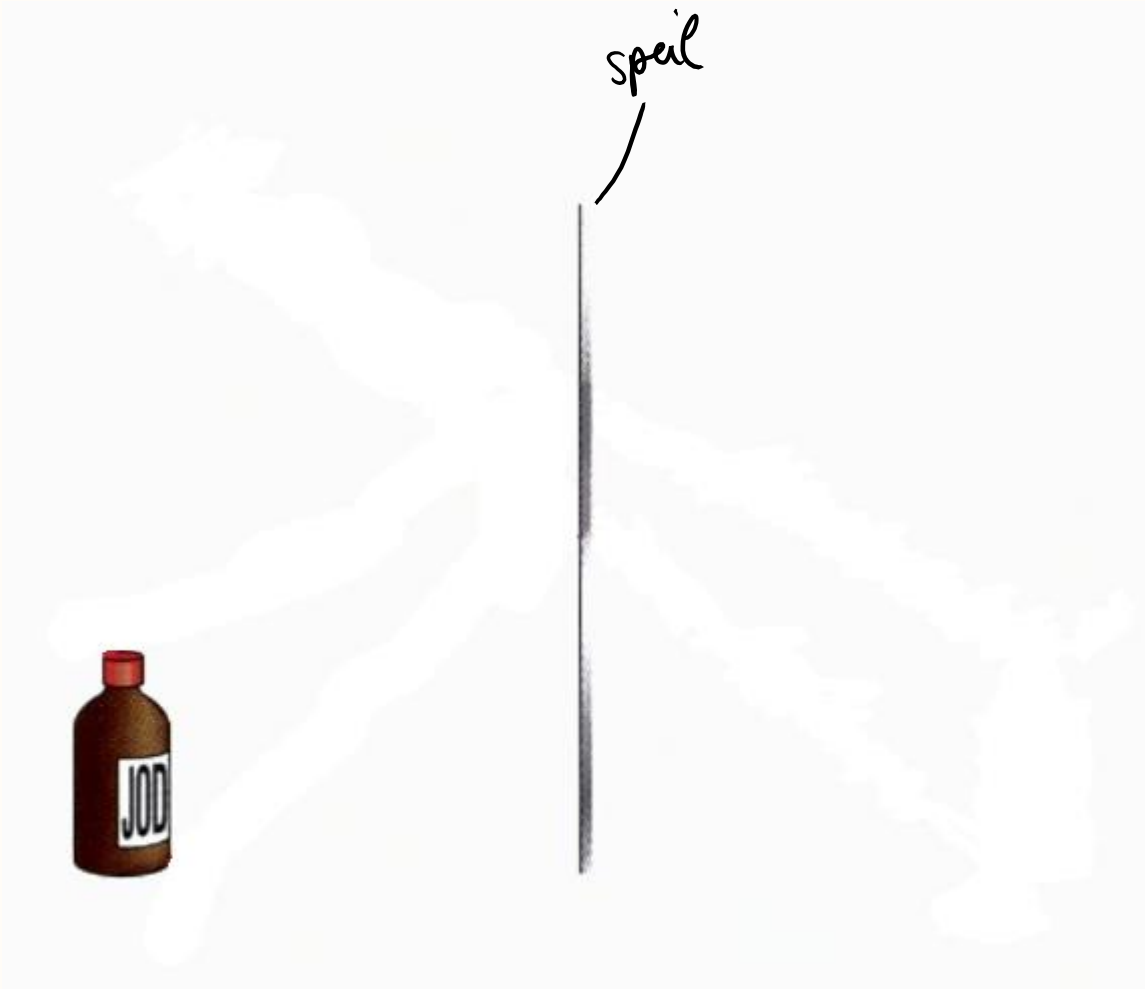

# Plan speil

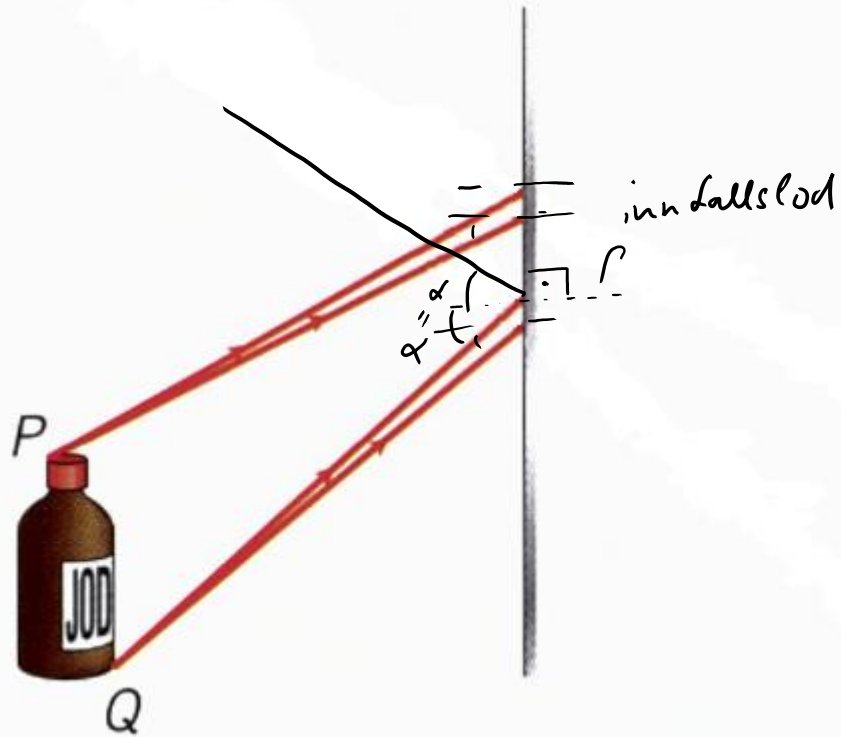

# Plan speil

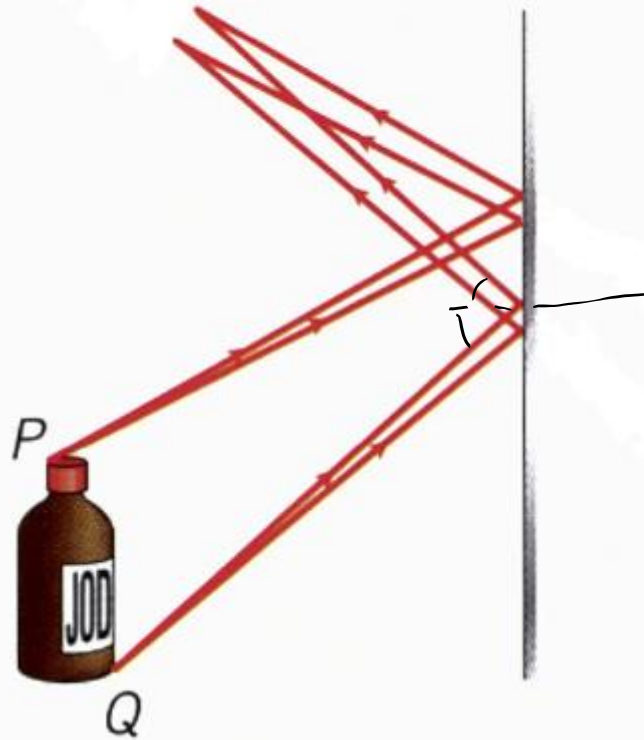

# Plan speil

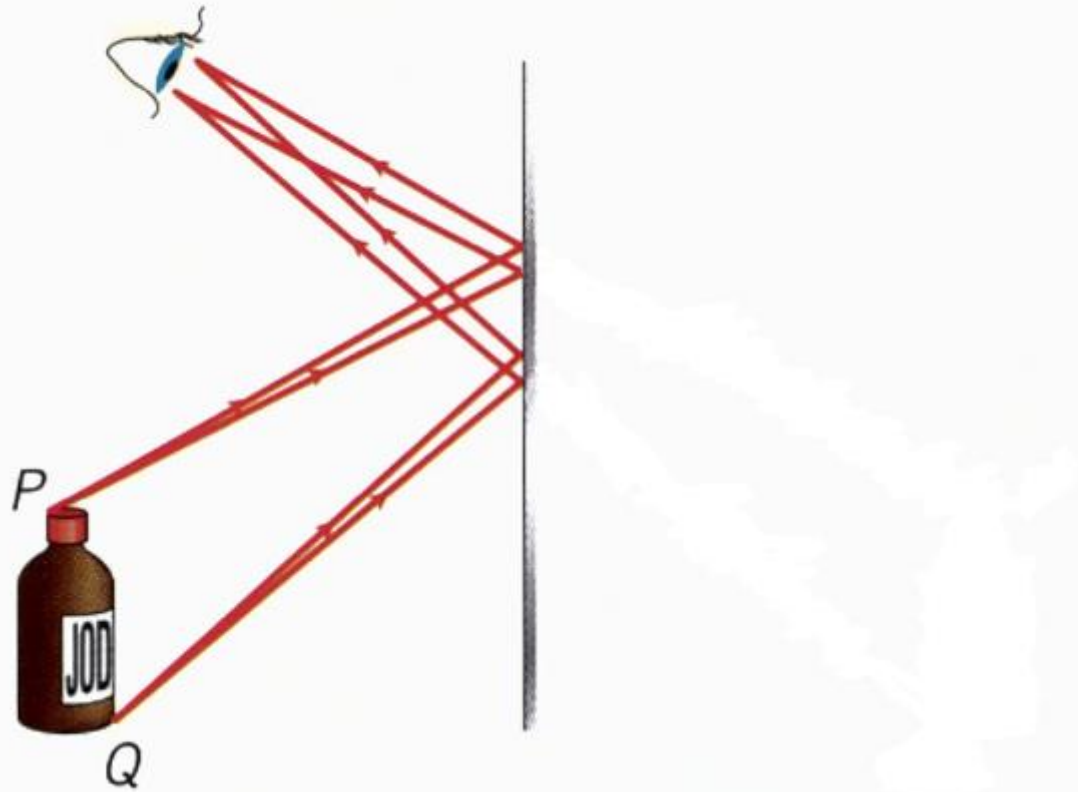



# Plan speil

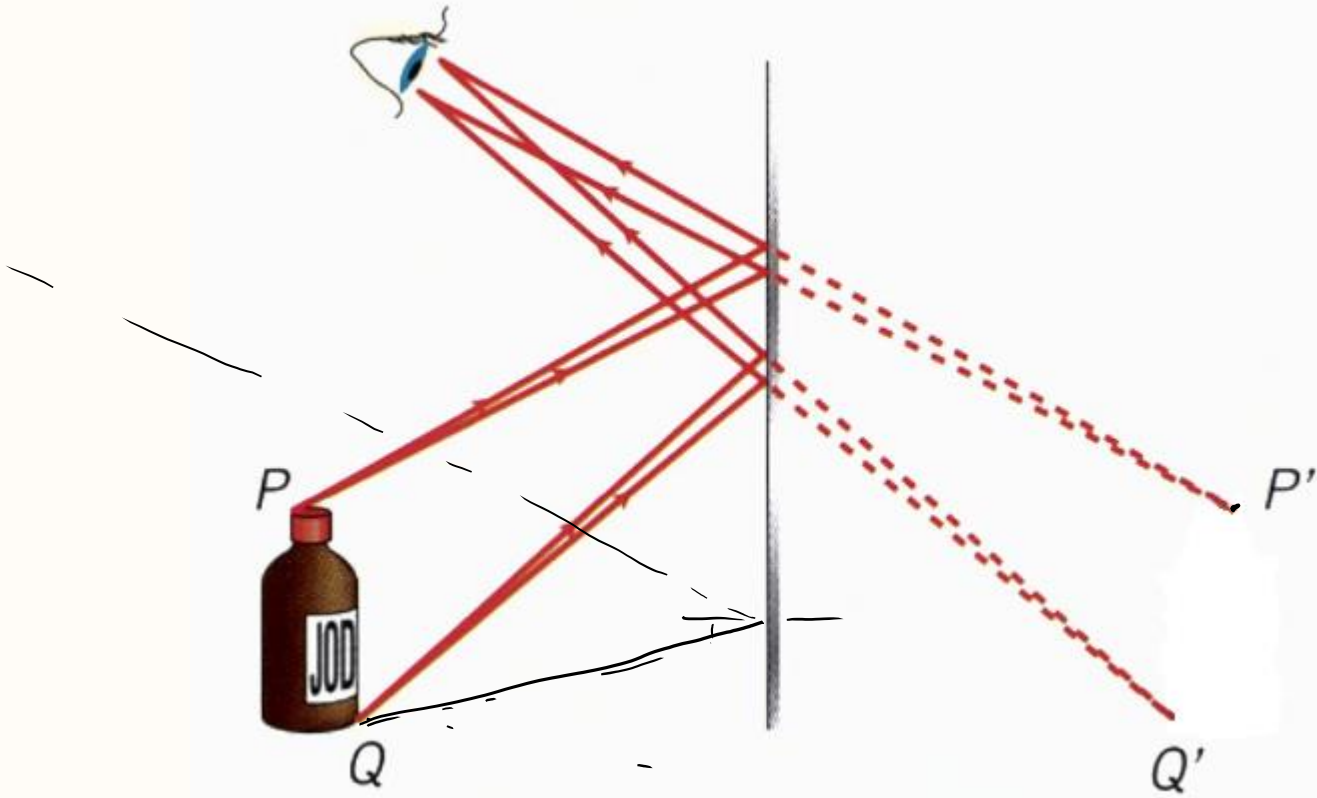

# Plan speil

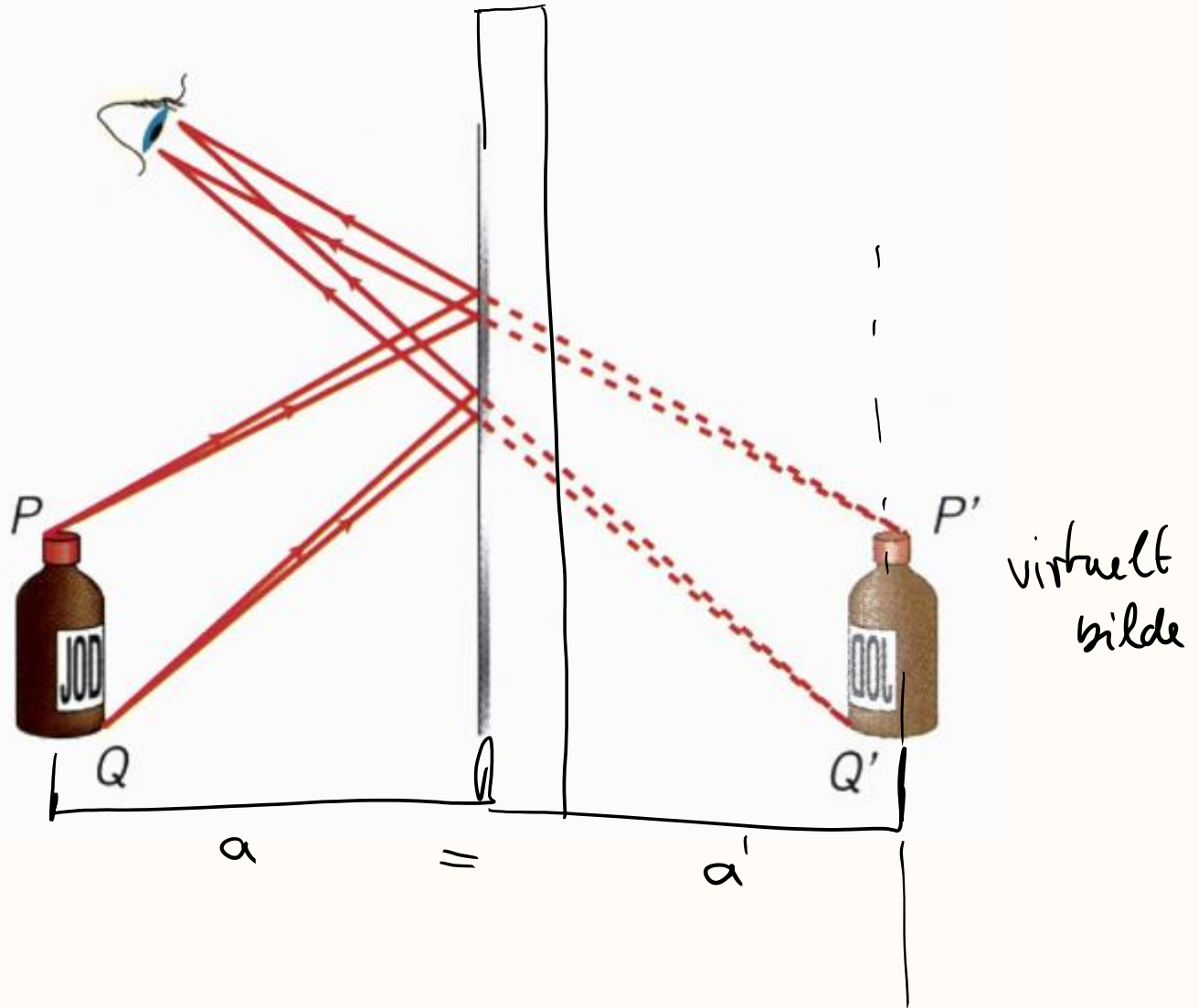

# Refleksjon, transmisjon

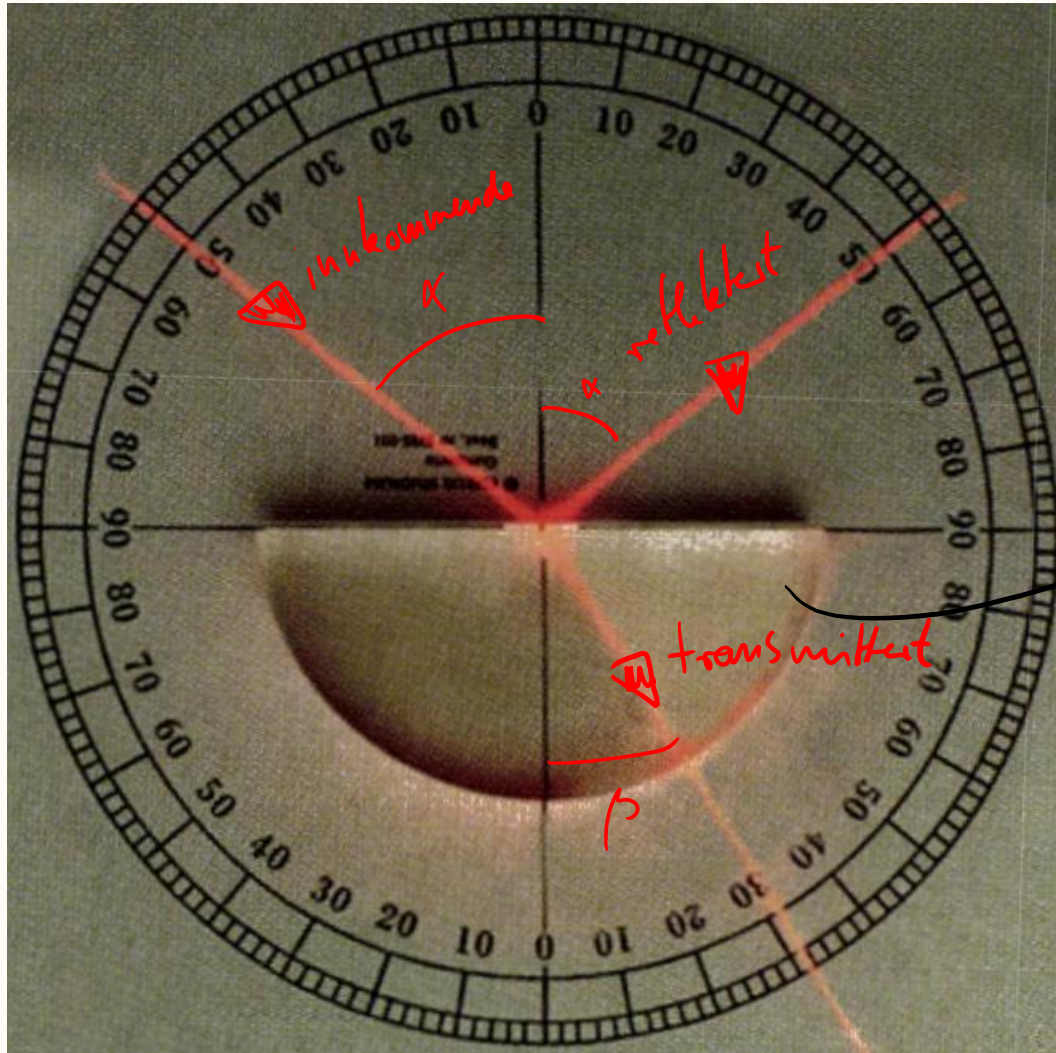

glass

# Snells lov

lysets hastighed  
i vacuum

brytningsindeks

$$n = \frac{c}{v}$$

lysets hastighed  
i material

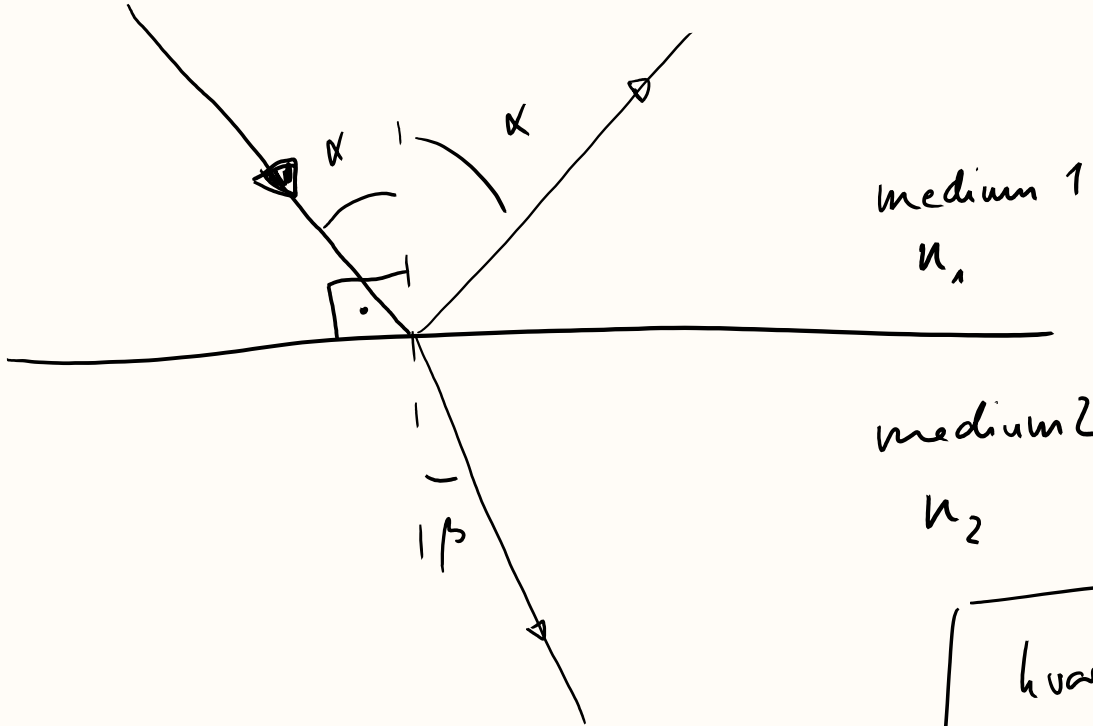

$$n_1 \sin \alpha = n_2 \sin \beta$$

hvor meget bliver reflekteret/  
transmitteret?

+ Fresnels ligninger

# Snells lov

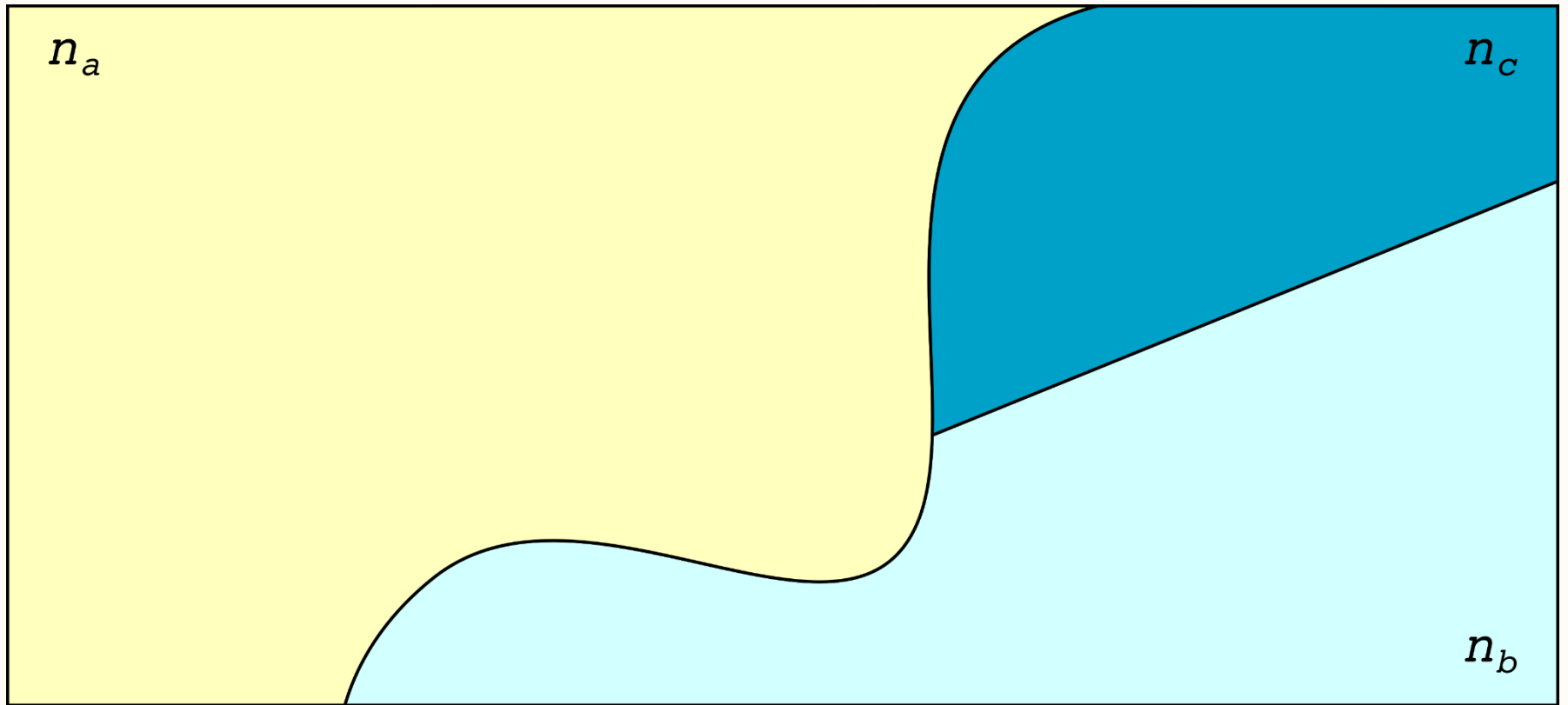

# Geometrisk optikk

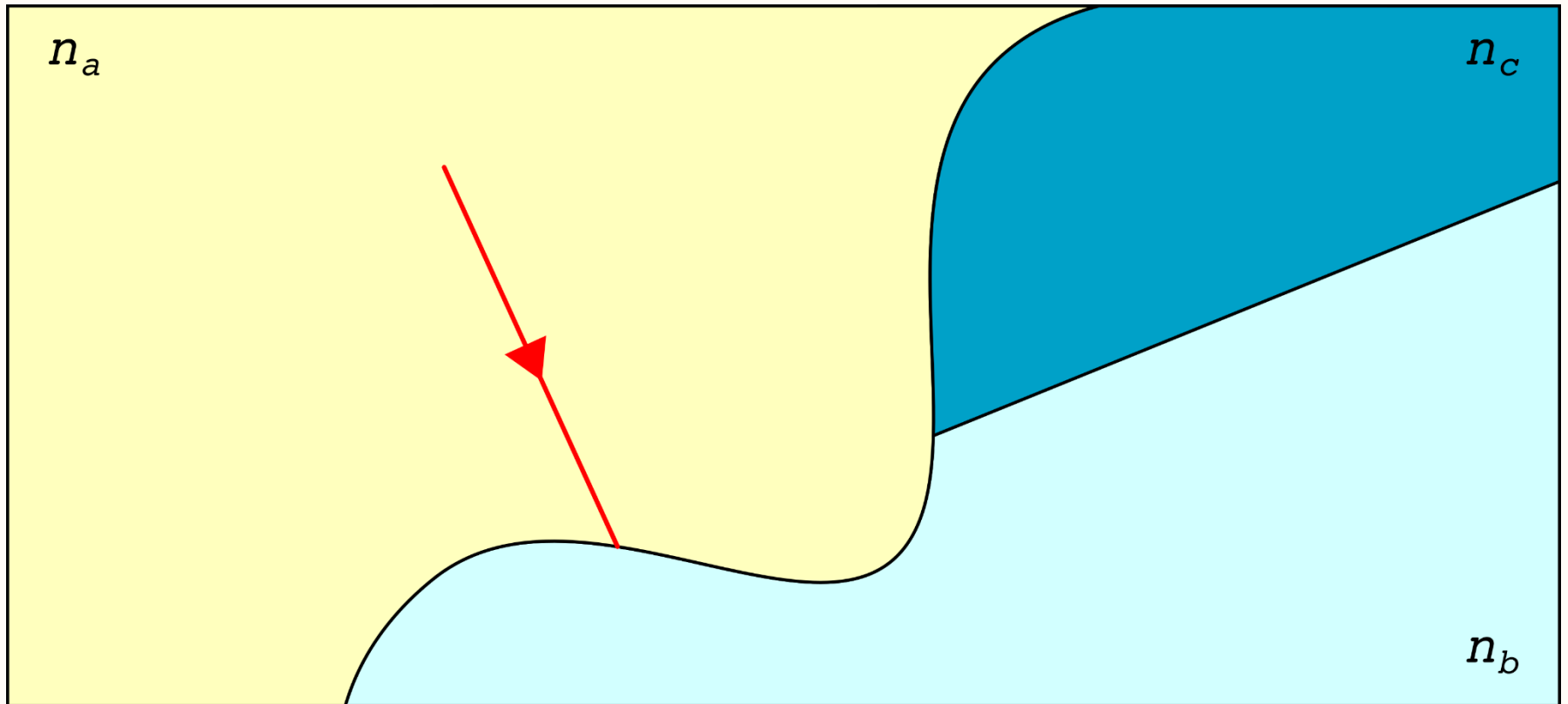

# Geometrisk optikk

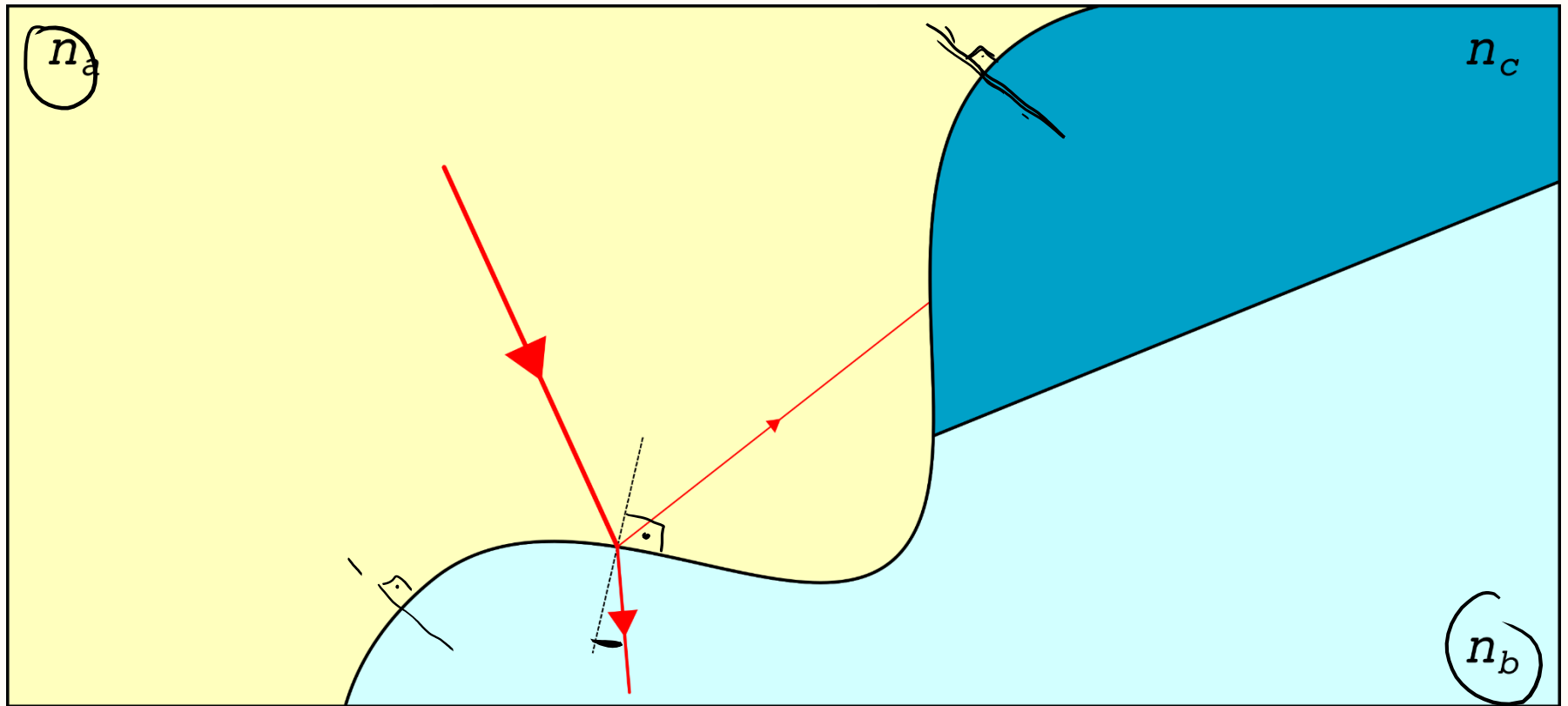

# Geometrisk optikk

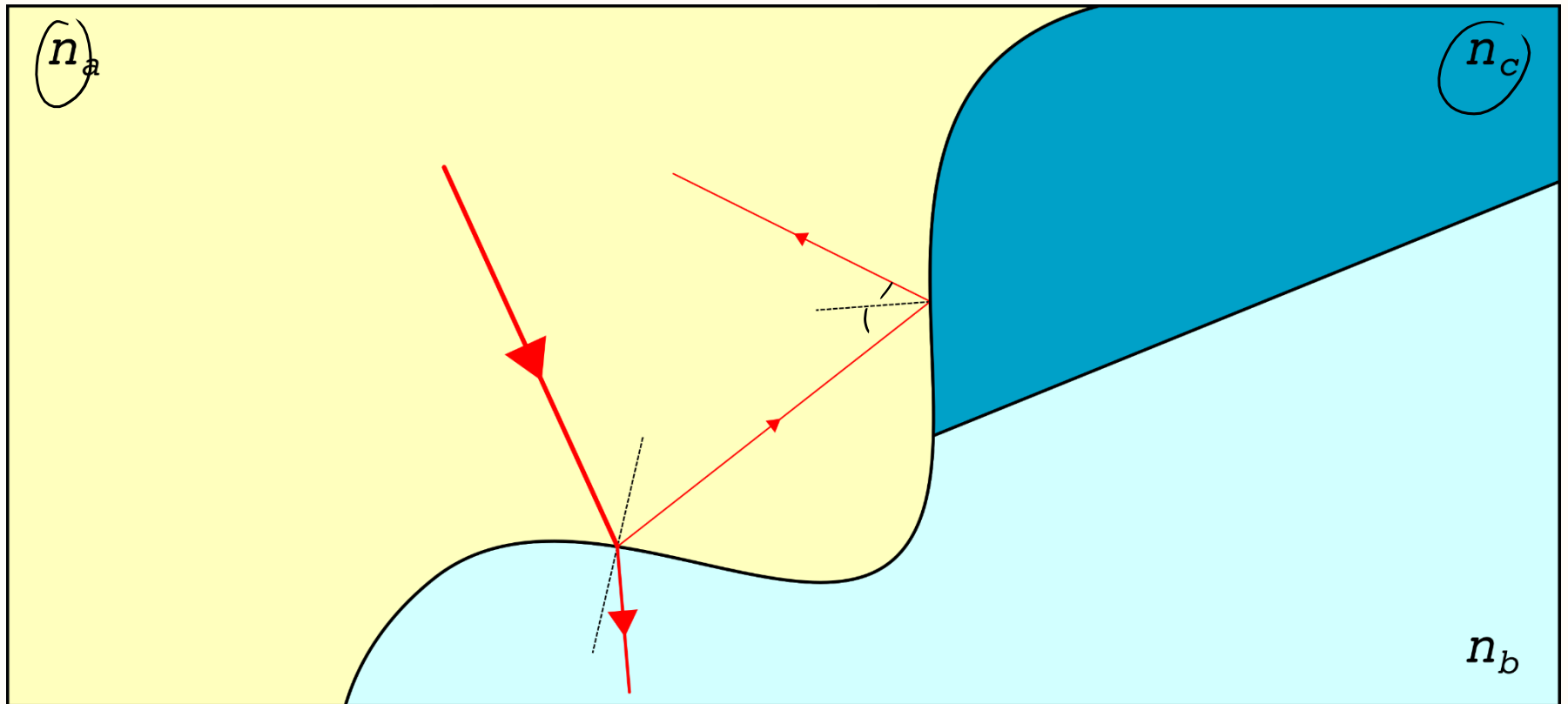



# Ray tracing

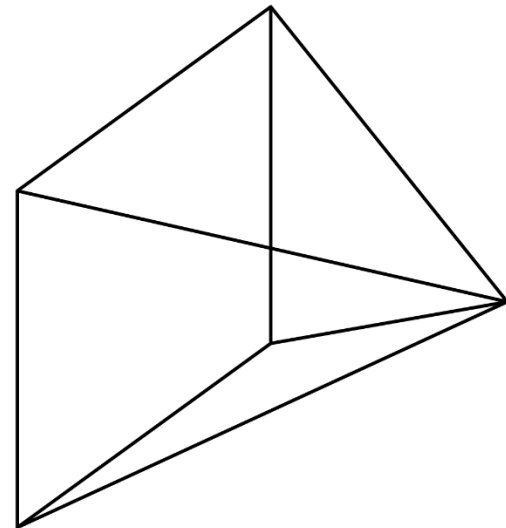

# Ray tracing

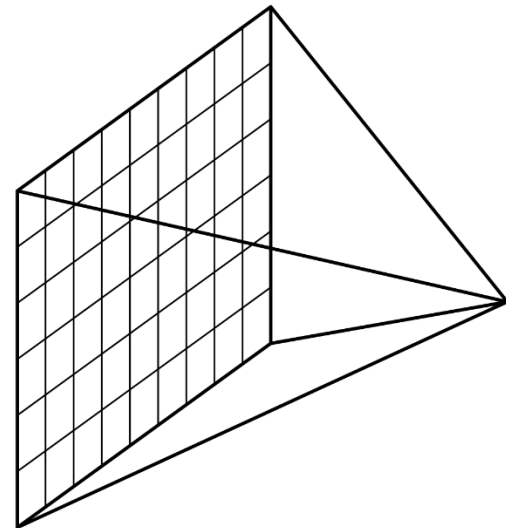

# Ray tracing

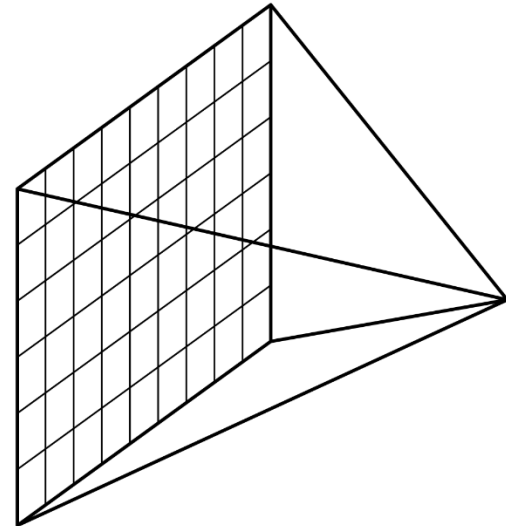
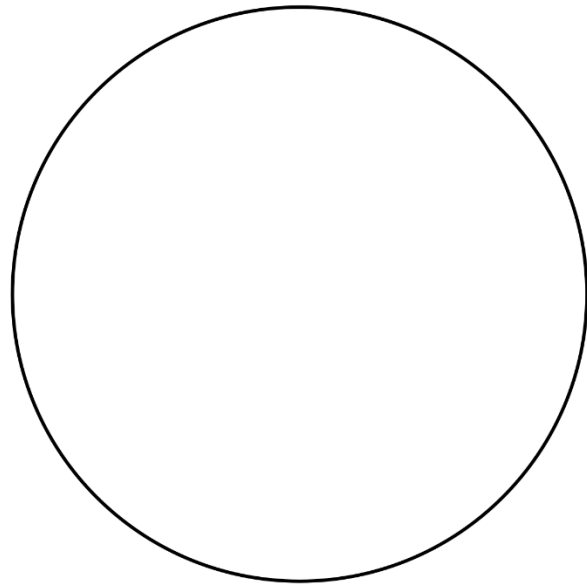

# Ray tracing

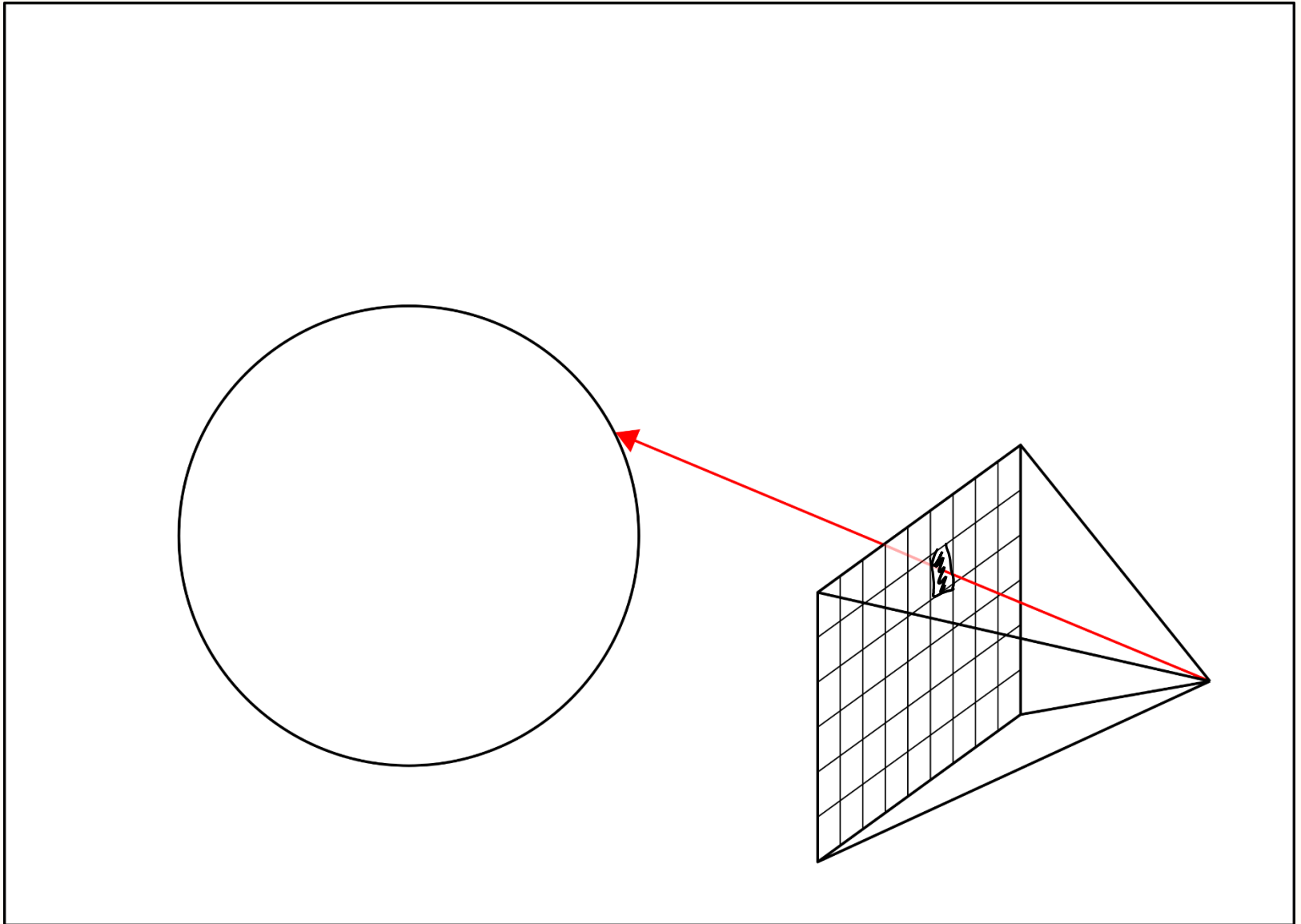

# Ray tracing

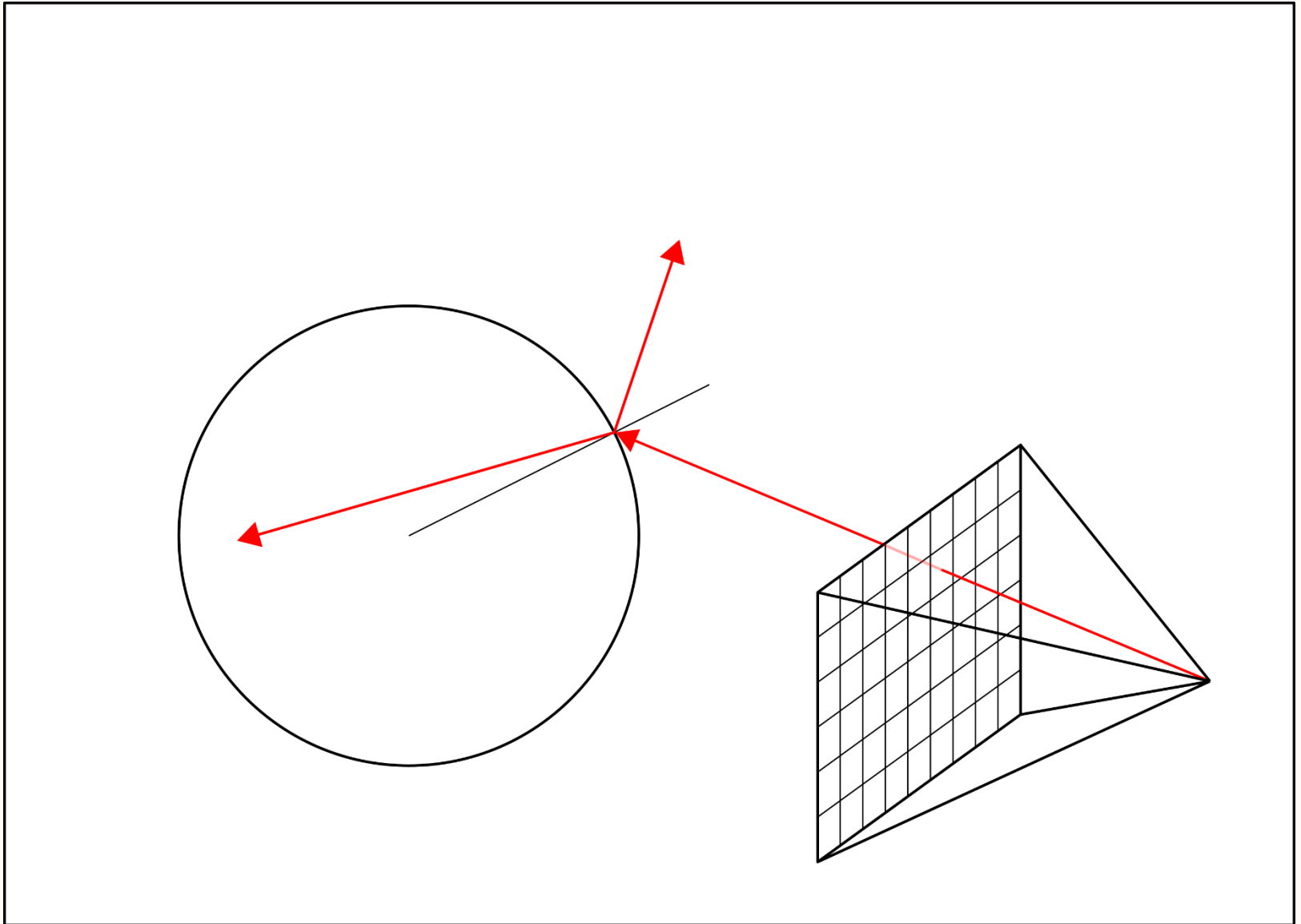

# Ray tracing

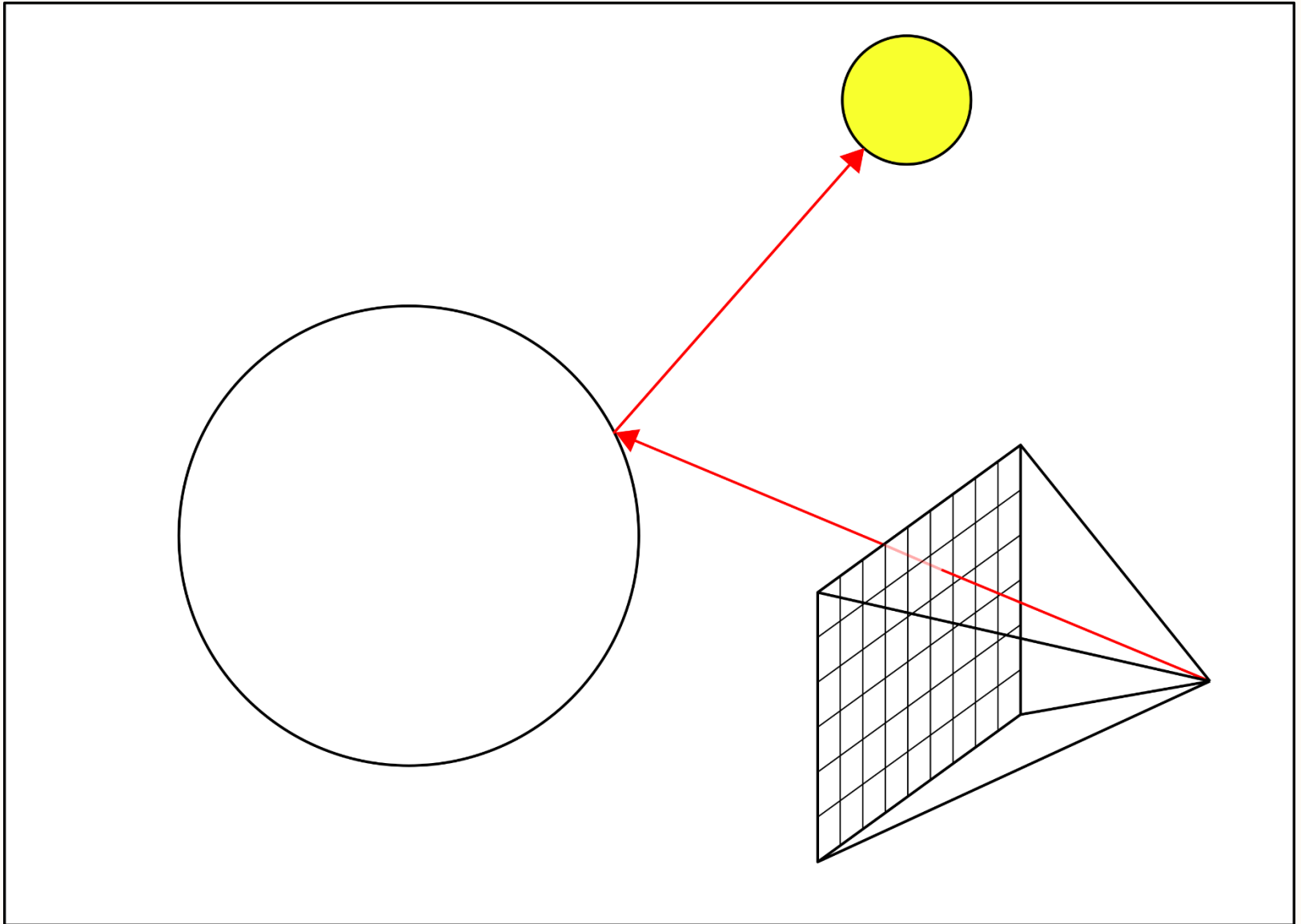

# Ray tracing

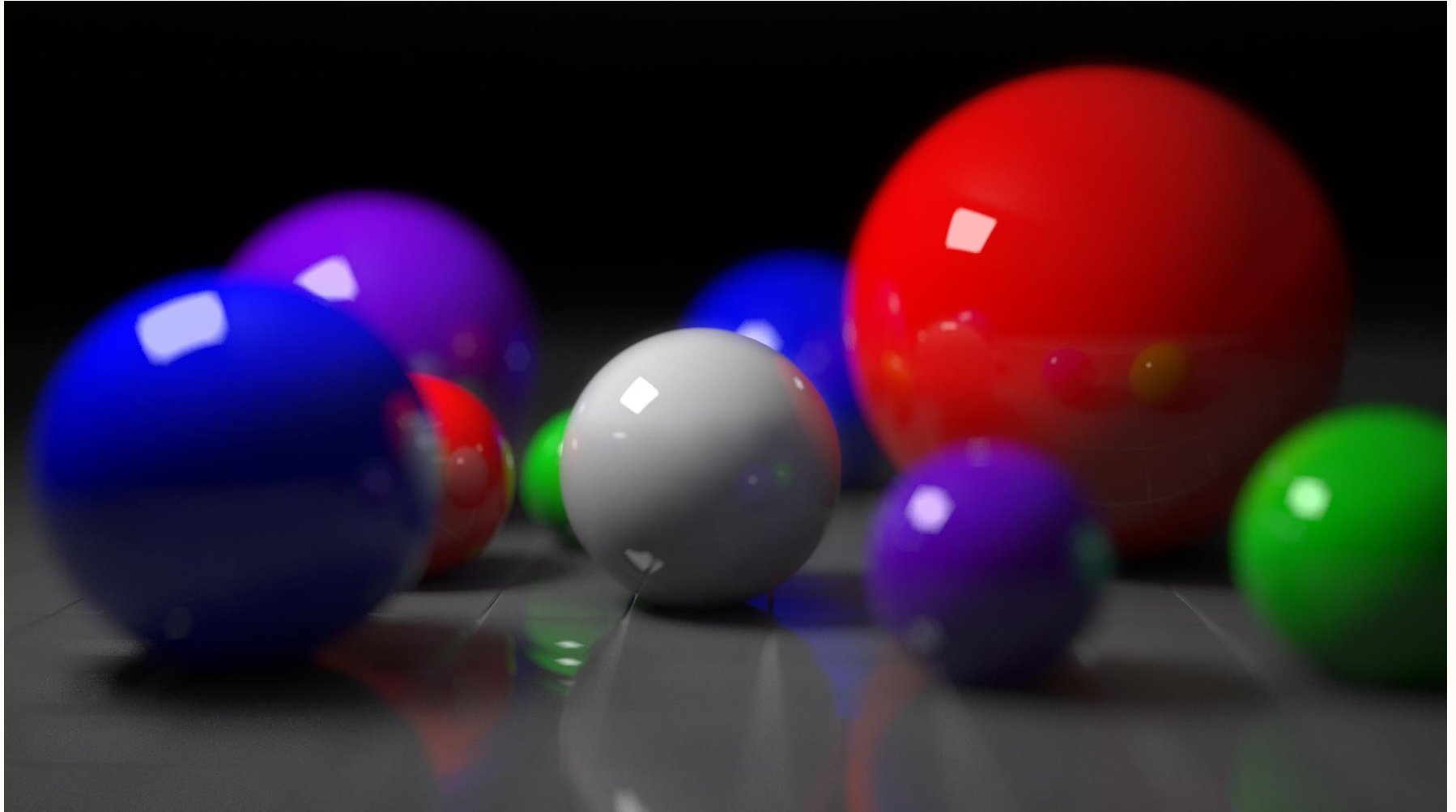

# Ray tracing





# Linser

glass  $n_g$



konvex



konkav

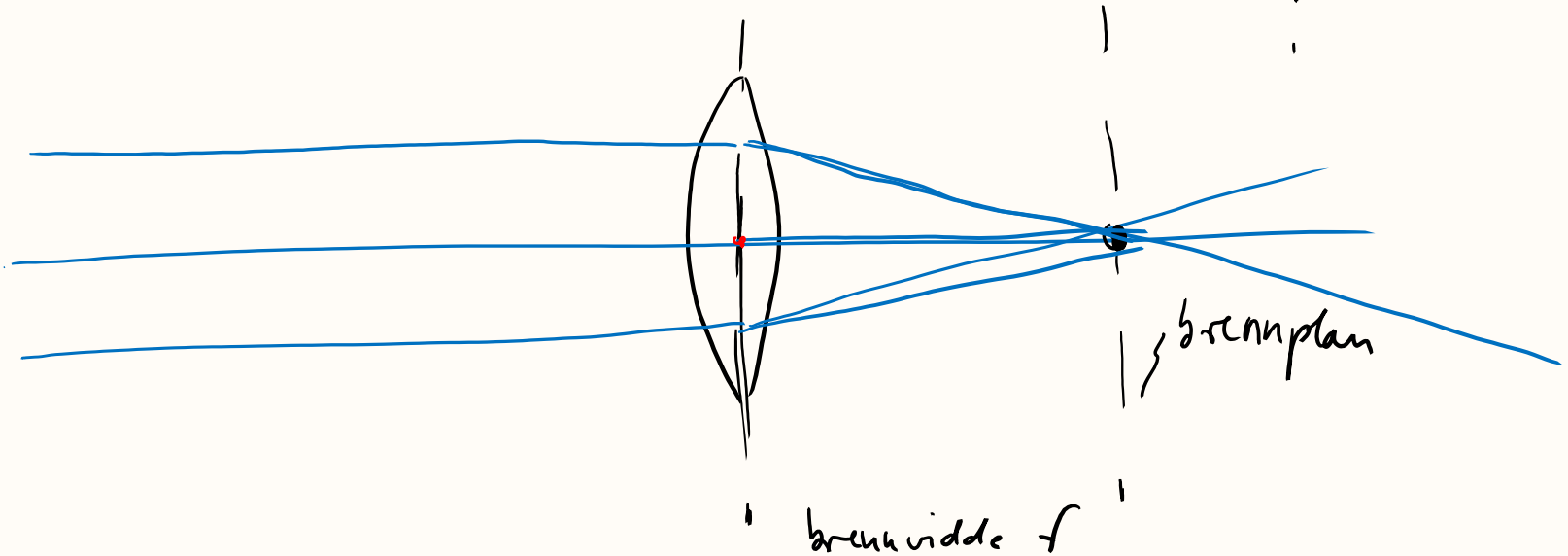
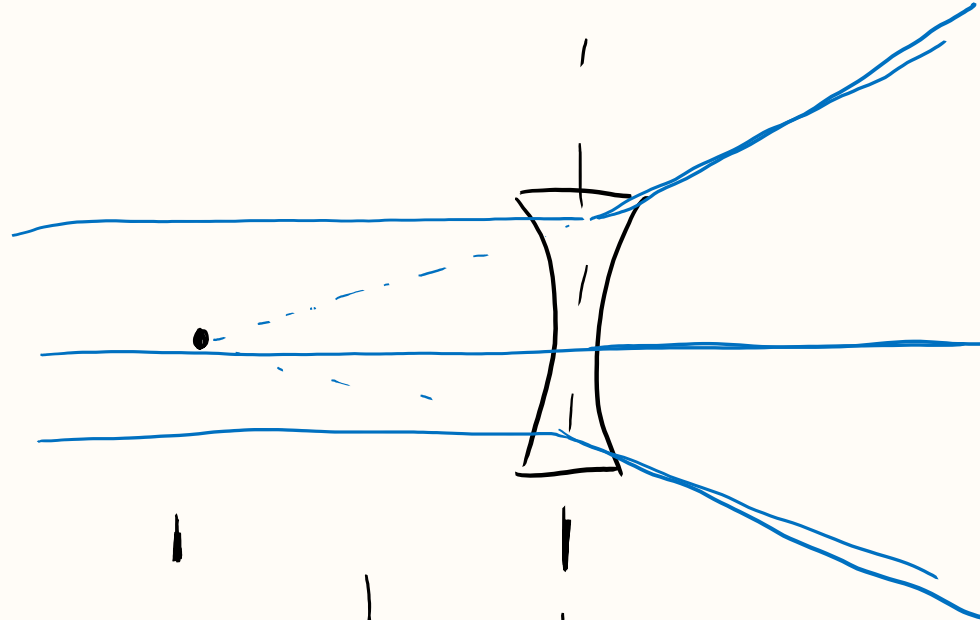

# Konveks linse

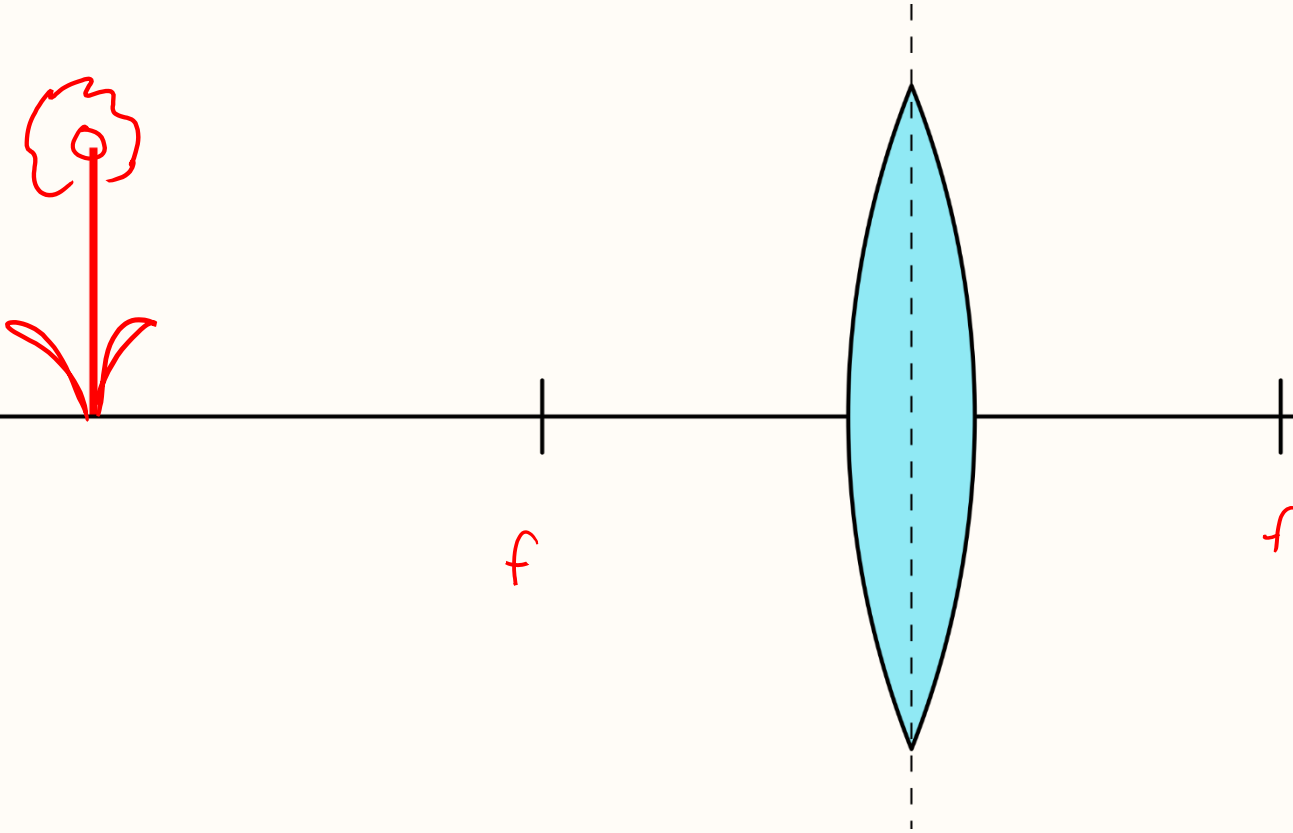

# Konveks linse

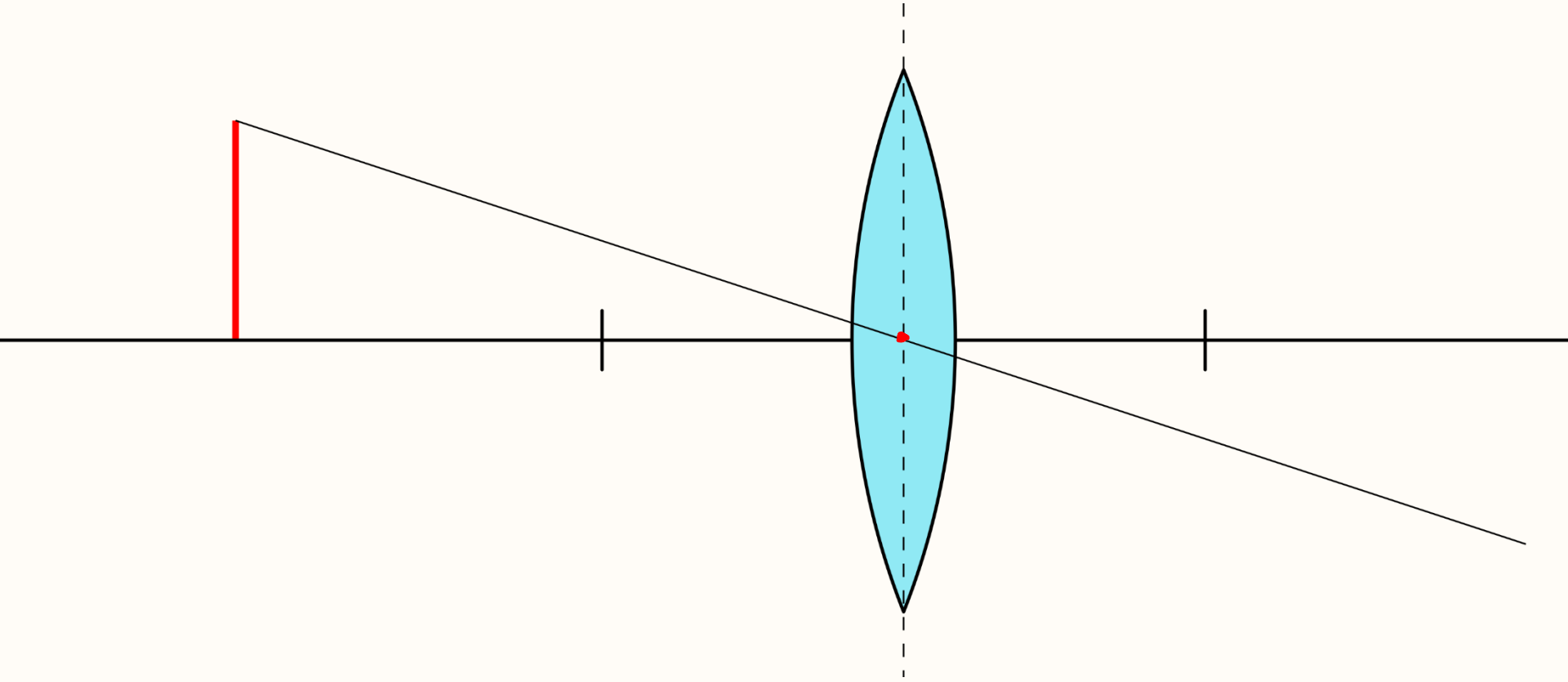

# Konveks linse

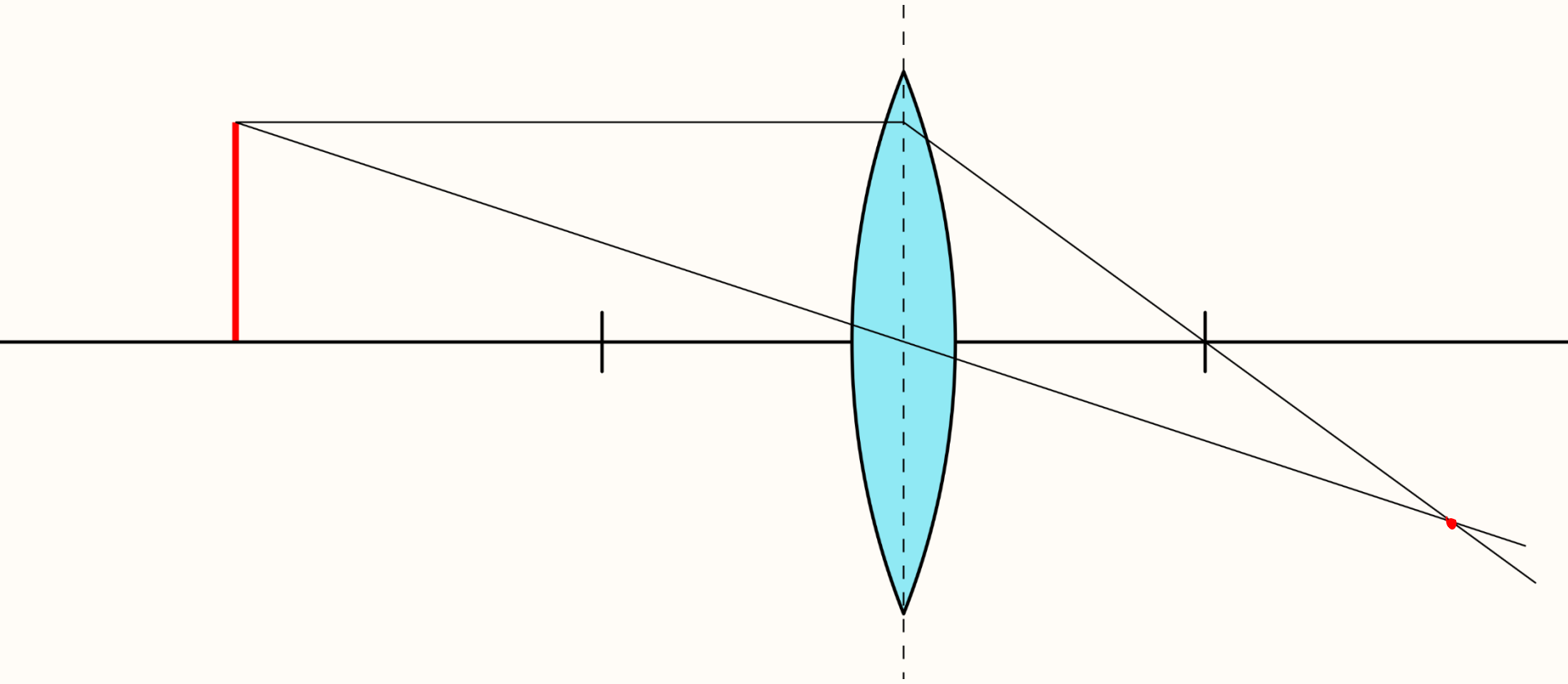

# Konveks linse

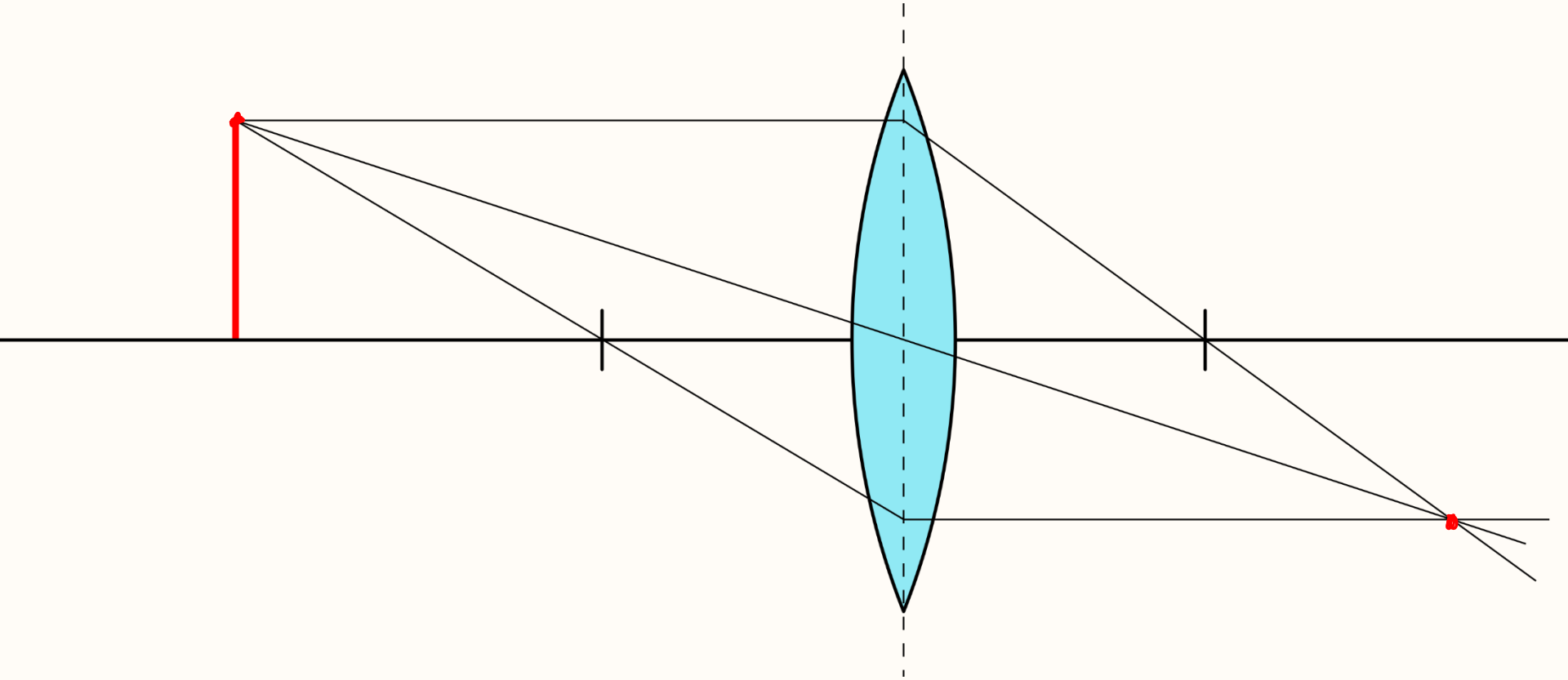

# Konveks linse

$$f > 0$$

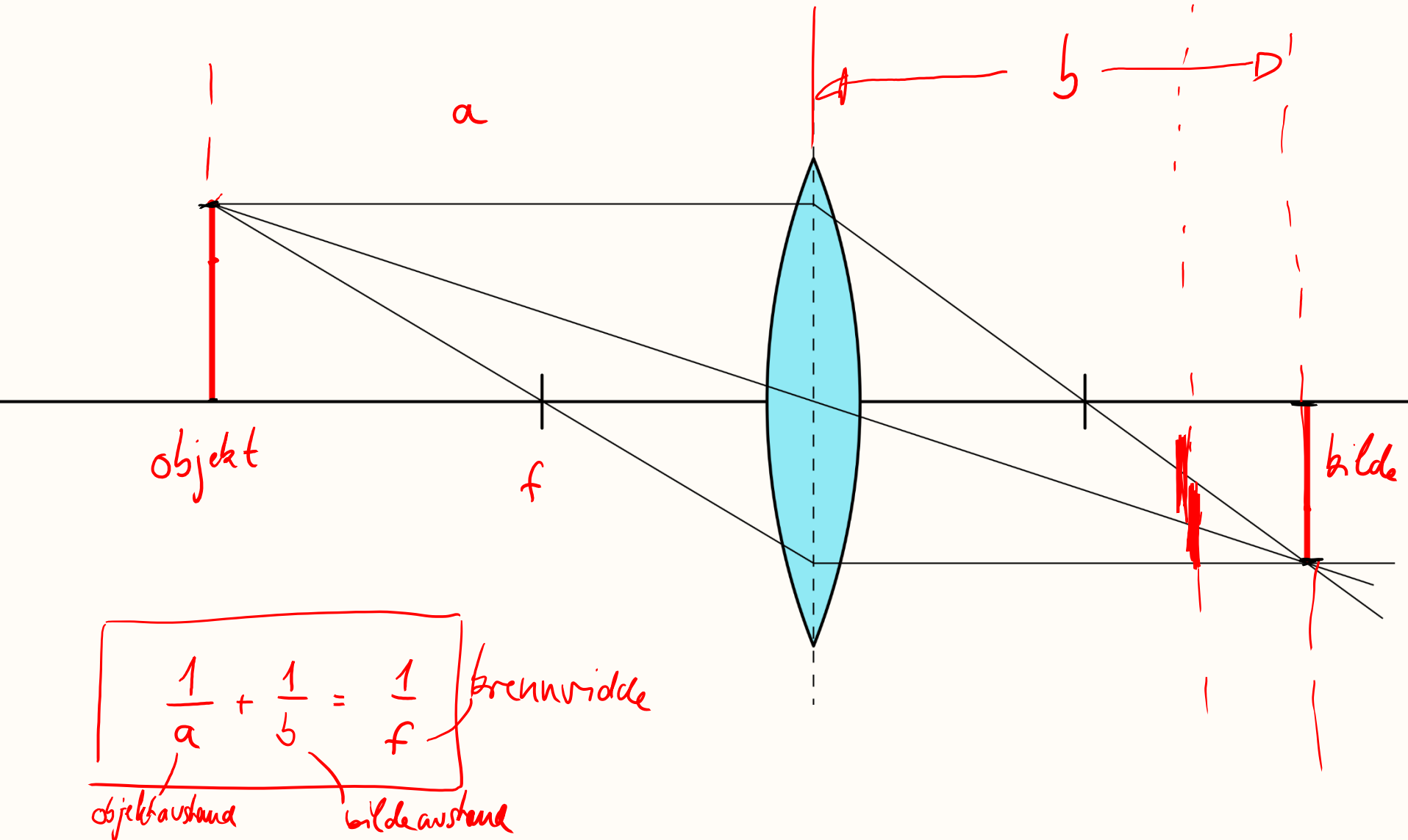

# Konkav linse

$$f < 0$$

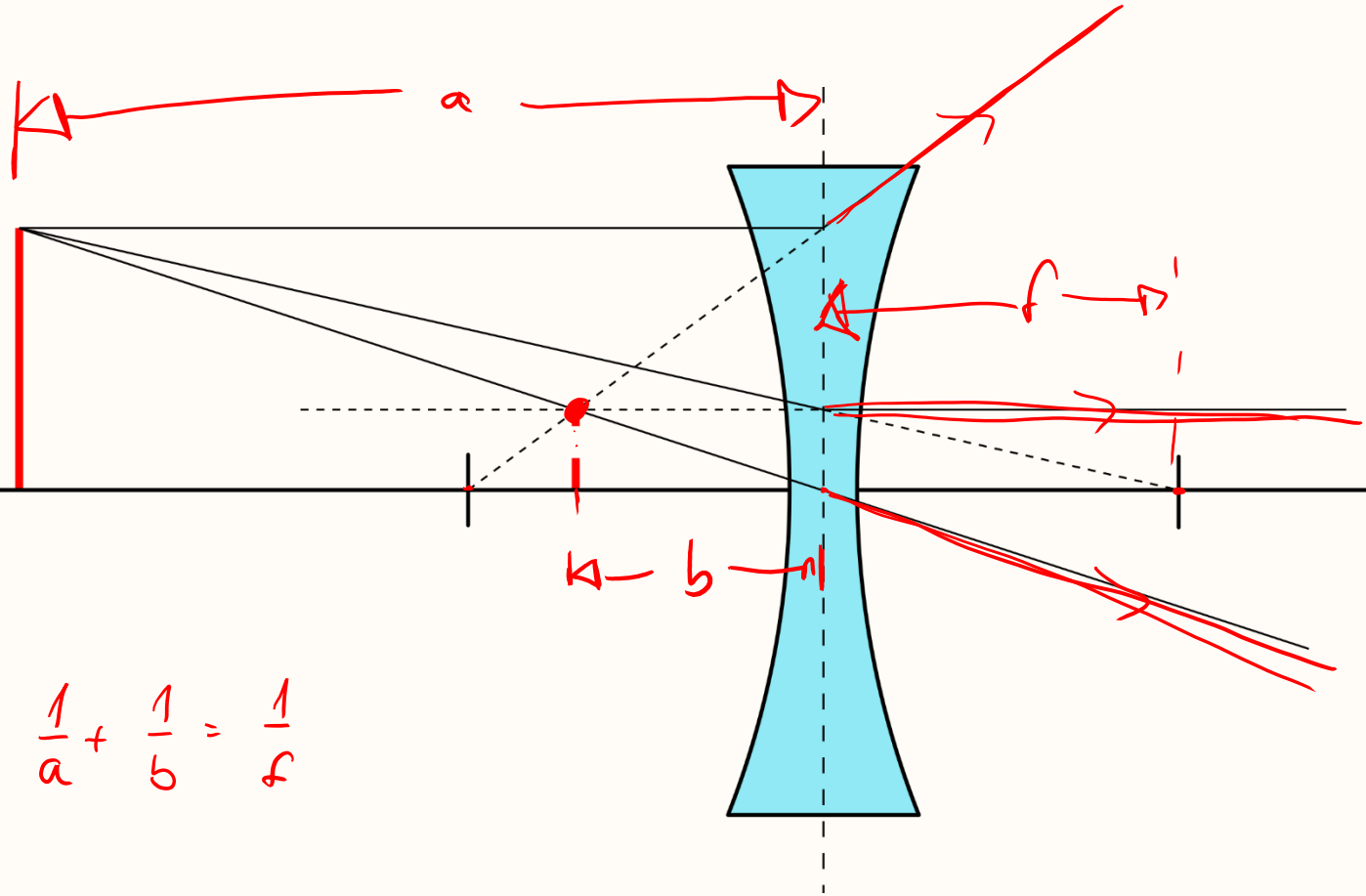

$$\frac{1}{a} + \frac{1}{b} = \frac{1}{f}$$

# Øyet

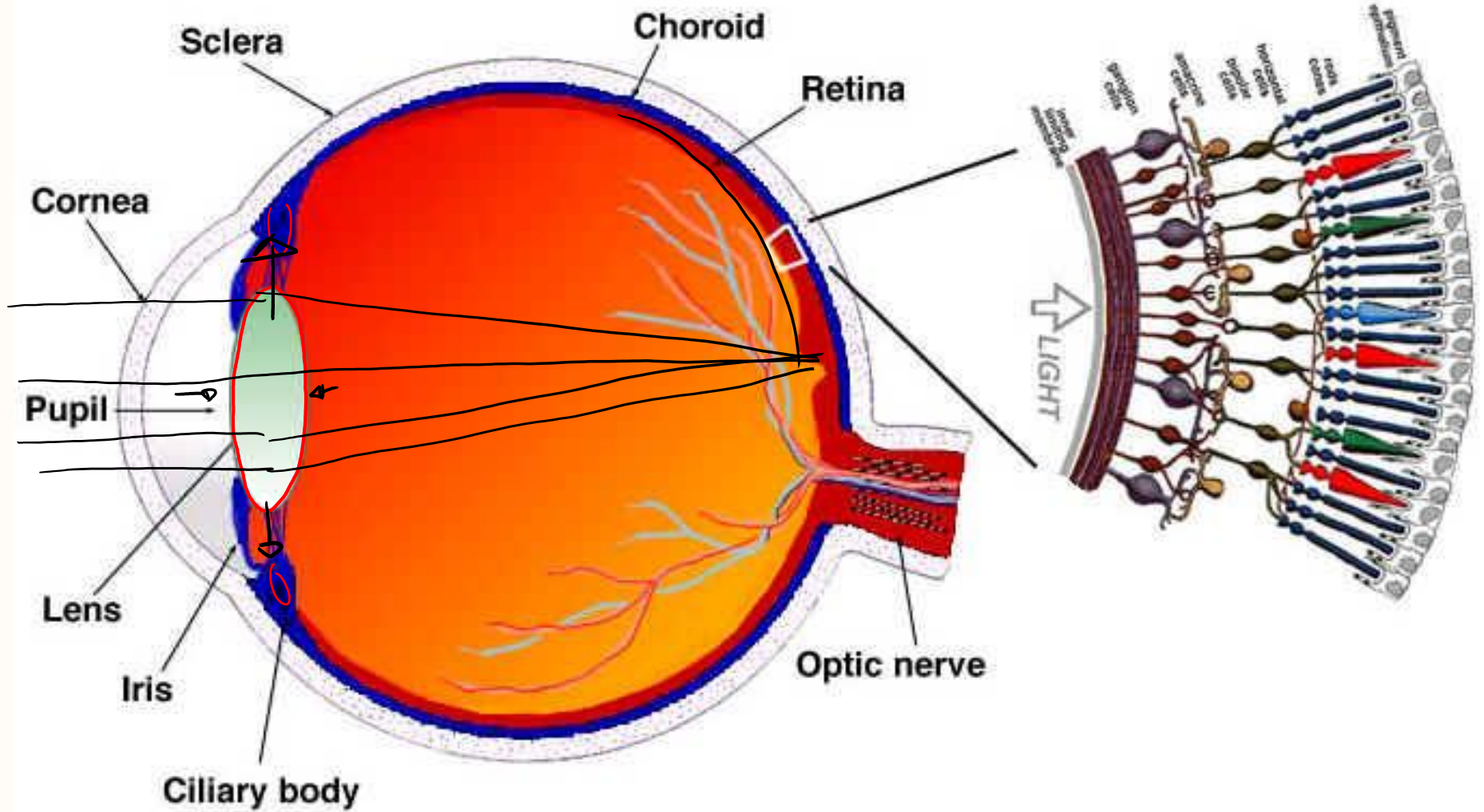



# Briller

Langsynthet

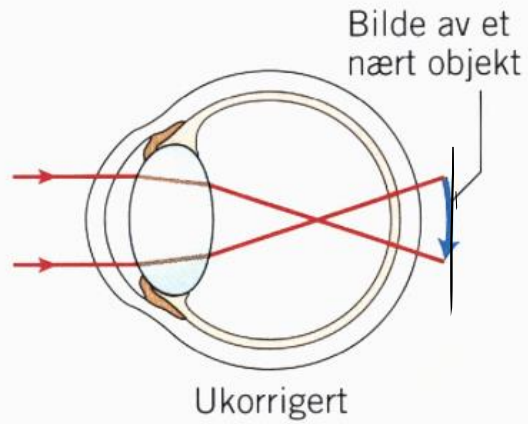

# Briller

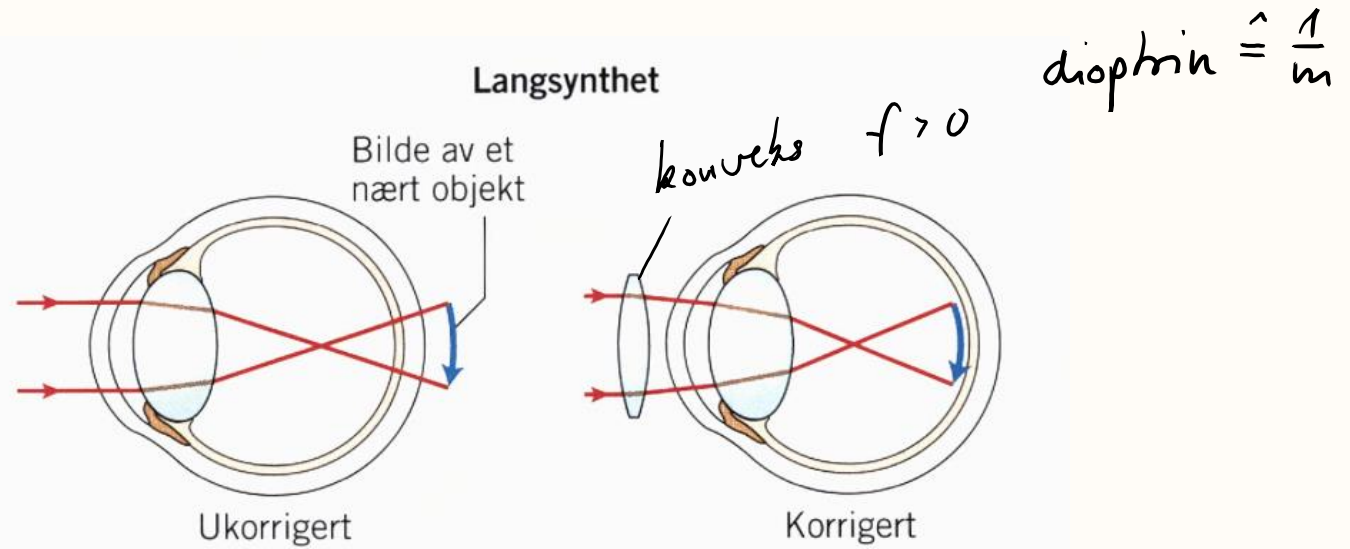

# Briller

## Langsynthet

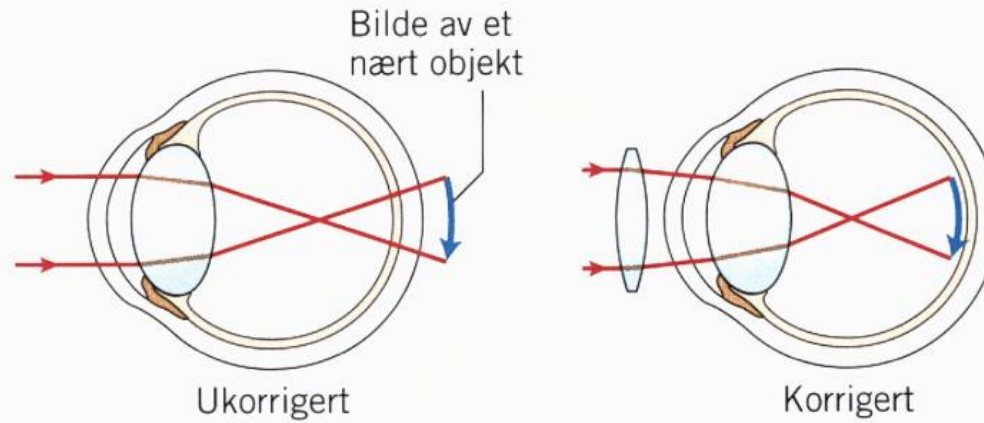

## Nærsynthet

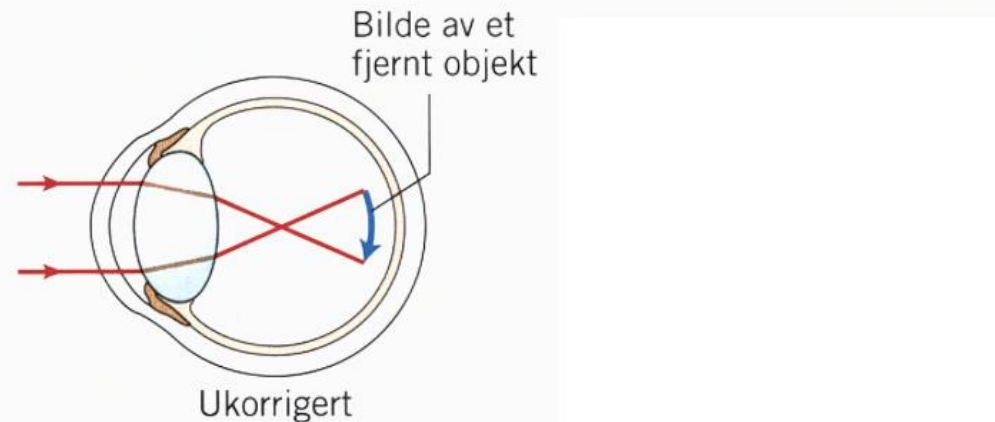

# Briller

## Langsynthet

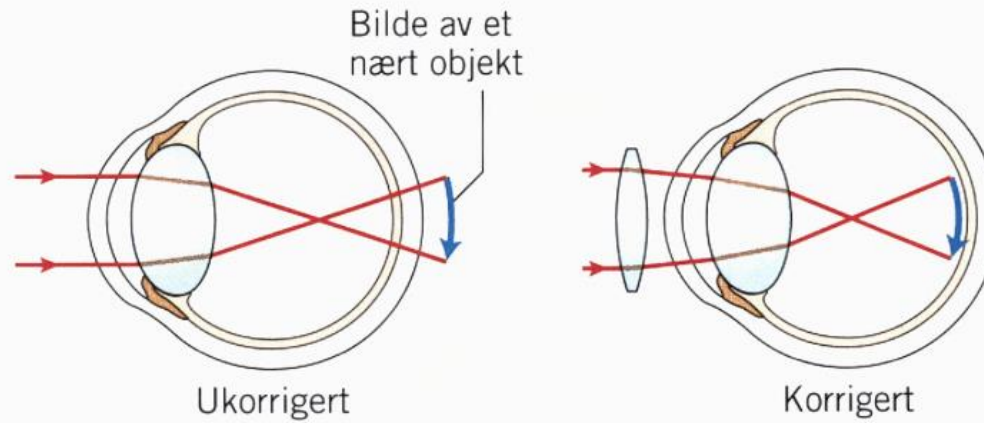

## Nærsynthet

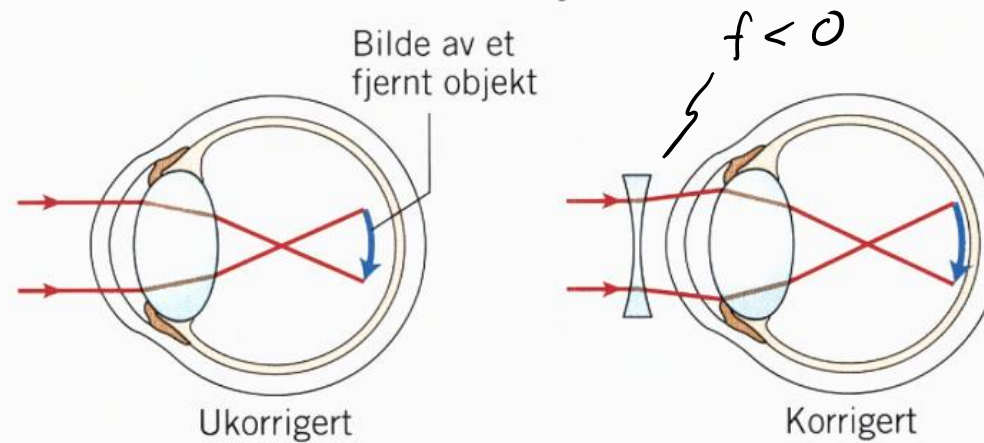

# Lupe

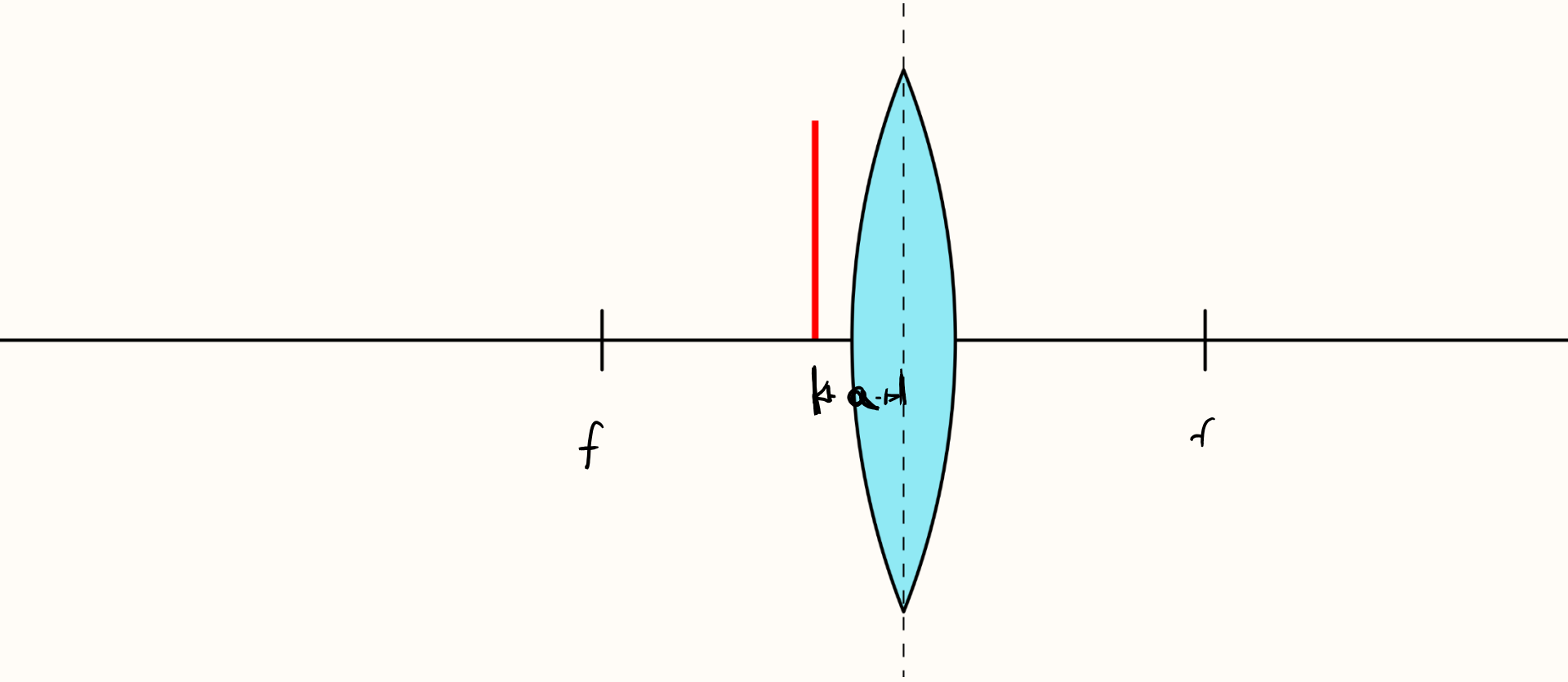

# Lupe

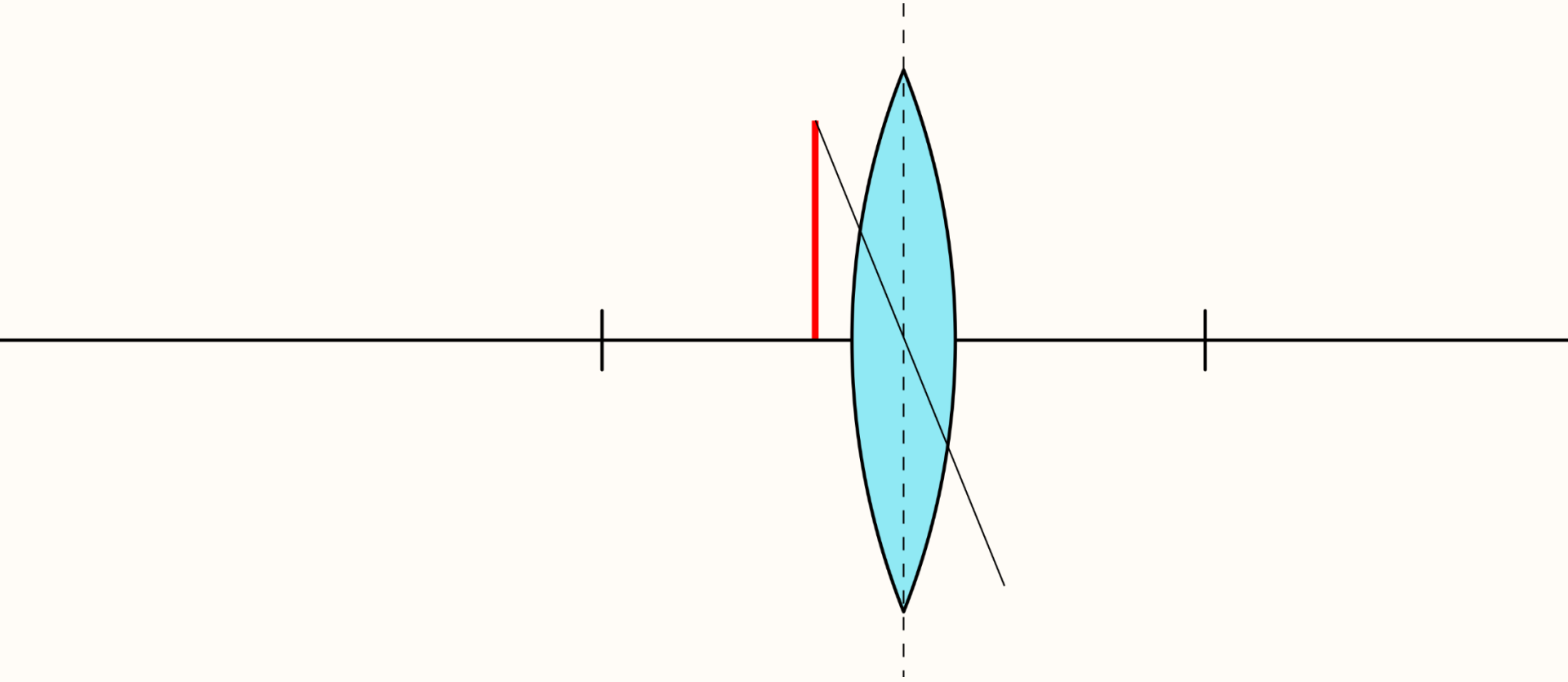

# Lupe

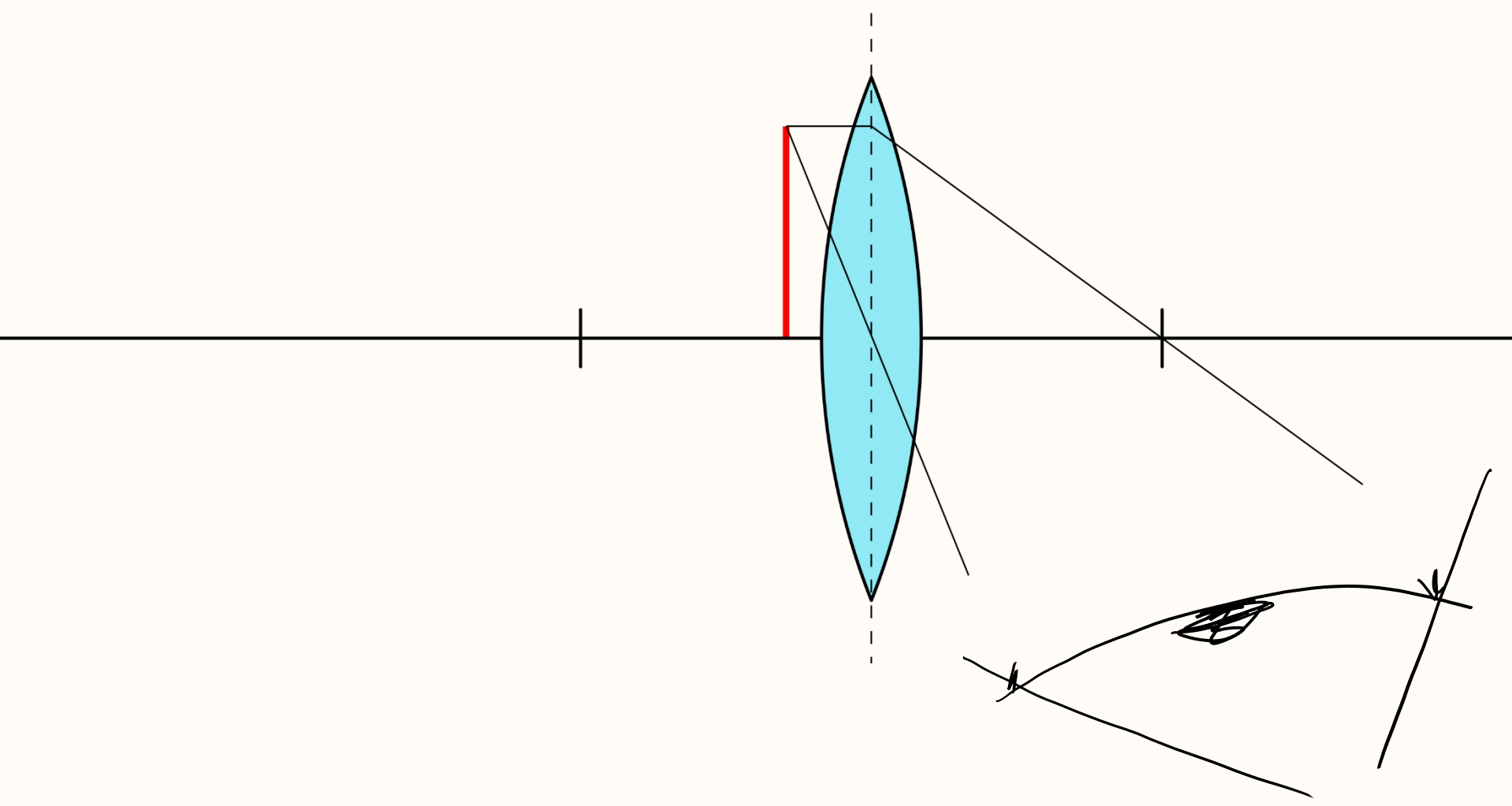

# Lupe

