

[Requirements and Compatibility](#) | [Ordering Information](#) | [Detailed Specifications](#) | [Pinouts/Front Panel Connections](#)

For user manuals and dimensional drawings, visit the product page resources tab on ni.com.

Last Revised: 2008-10-02 10:50:20.0

Bus-Powered M Series Multifunction DAQ for USB - 16-Bit, up to 400 kS/s, up to 32 Analog Inputs, Isolation



- Up to 32 analog inputs at 16 bits, up to 400 kS/s (250 kS/s scanning)
- Up to 2 analog outputs at 16 bits
- Up to 32 TTL/CMOS digital I/O lines
- Two 32-bit, 80 MHz counter/timers

- NI-PGIA 2 and NI-MCal calibration technology for improved measurement accuracy
- NI signal streaming for 4 high-speed data streams on USB
- Bus-powered design
- Available with CAT I isolation

Overview

With recent bandwidth improvements and new innovations from National Instruments, USB has evolved into a core bus of choice for measurement and automation applications. NI M Series devices for USB deliver high-performance data acquisition in an easy-to-use and portable form factor through USB ports on laptop computers and other portable computing platforms. National Instruments designed the new and innovative patent-pending NI signal streaming technology that enables sustained bidirectional high-speed data streams on USB. The new technology, combined with advanced external synchronization and isolation, helps engineers and scientists achieve high-performance applications on USB.

NI M Series bus-powered multifunction data acquisition (DAQ) devices for USB are optimized for superior accuracy in a small form factor. They provide an onboard NI-PGIA 2 amplifier designed for fast settling times at high scanning rates, ensuring 16-bit accuracy even when measuring all available channels at maximum speed.

All bus-powered devices have a minimum of 16 analog inputs, digital triggering, and two counter/timers. USB M Series devices are ideal for test, control, and design applications including portable data logging, field monitoring, embedded OEM, in-vehicle data acquisition and academic.

[Back to Top](#)

Requirements and Compatibility

OS Information

- Windows 2000/XP
- Windows Vista x64/x86
- Linux®
- Mac OS X

Driver Information

- NI-DAQmx Base
- NI-DAQmx

Software Compatibility

- ANSI C/C++
- LabVIEW
- LabVIEW SignalExpress
- Measurement Studio
- LabWindows/CVI

[Back to Top](#)

Comparison Tables

Family	Connector	Analog Inputs	Resolution (bits)	Max Rate (kS/s)	Analog Outputs	Resolution (bits)	Max Rate (kS/s)	Digital I/O	Isolation
USB-6210	Screw	16	16	250	-	-	-	4 DI/4 DO	-
USB-6211	Screw	16	16	250	2	16	250	4 DI/4 DO	-
USB-6212	Screw/68-pin SCSI	16	16	400	2	16	250	24 or 32 DIO	-
USB-6215	Screw	16	16	250	2	16	250	4 DI/4 DO	60 V, CAT I
USB-6216	Screw/68-pin SCSI	16	16	400	2	16	250	24 or 32 DIO	60 V, CAT I
USB-6218	Screw	32	16	250	2	16	250	8 DI/8 DO	60 V, CAT I

[Back to Top](#)

Application and Technology

NI Signal Streaming

To optimize the use of the Universal Serial Bus (USB) and deliver high-performance data acquisition, National Instruments created several key technologies to push the limits of USB throughput and latency. NI signal streaming combines three innovative hardware- and software-level design elements to enable sustained high-speed and bidirectional data streams over USB. For more information, visit ni.com/usb.

USB M Series for Test

You can use USB M Series multifunction DAQ devices for low-cost test or to complement existing test systems that need additional measurement channels. For higher-channel-count signal conditioning on USB, consider the NI CompactDAQ or SCXI platforms.

USB M Series for Design

For design applications, you can use a wide range of I/O – from 16 differential analog inputs to 32 digital lines – to measure and verify prototype designs. USB M Series devices and NI LabVIEW SignalExpress interactive measurement software deliver benchtop measurements to the PC. With LabVIEW SignalExpress, you can quickly create design verification tests. You can convert your tested and verified LabVIEW SignalExpress projects to LabVIEW applications for immediate M Series DAQ use, and bridge the gap between test, control, and design applications.

USB M Series for OEM

Shorten your time to market by integrating world-class National Instruments OEM measurement products in your design. Board-only versions of USB M Series DAQ devices for OEM applications feature competitive quantity pricing and software customization. The NI OEM Elite Program offers free 30-day trial kits for qualified customers. Visit ni.com/oem for more information.

Recommended Driver Software

National Instruments measurement services software, built around NI-DAQmx driver software, includes intuitive application programming interfaces, configuration tools, I/O assistants, and other tools designed to reduce system setup, configuration, and development time. National Instruments recommends using the latest version of NI-DAQmx driver software for application development in NI LabVIEW, LabVIEW SignalExpress, LabWindows™/CVI, and Measurement Studio software. To obtain the latest version of NI-DAQmx, visit ni.com/support/daq/versions. NI measurement services software speeds up your development with features including the following:

- A guide to create fast and accurate measurements with no programming using the DAQ Assistant
 - Automatic code generation to create your application in LabVIEW; LabWindows/CVI; LabVIEW SignalExpress; and C#, Visual Studio .NET, ANSI C/C++, or Visual Basic using Measurement Studio
 - Multithreaded streaming technology for 1,000 times performance improvements
 - Automatic timing, triggering, and synchronization routing to make advanced applications easy
 - More than 3,000 free software downloads available at ni.com/zone to jump-start your project
 - Software configuration of all digital I/O features without hardware switches/jumpers
 - Single programming interface for analog input, analog output, digital I/O, and counters on hundreds of multifunction DAQ hardware devices
- M Series devices are compatible with the following versions (or later) of NI application software – LabVIEW, LabWindows/CVI, or Measurement Studio versions 7.x; and LabVIEW

Recommended Accessories (Mass-Terminal Versions)

Signal conditioning is required for sensor measurements or voltage inputs greater than 10 V. NI SCC products, which are designed to increase the performance and reliability of your data acquisition system, are up to 10 times more accurate than using terminal blocks alone. For more information, visit ni.com/sigcon.

[Back to Top](#)

Ordering Information

For a complete list of accessories, visit the product page on ni.com.

Products	Part Number	Recommended Accessories	Part Number
NI USB-6212			
NI USB-6212	780107-01	No accessories required.	
NI USB-6216			
NI USB-6216	780108-01	No accessories required.	
NI USB-6212			
NI USB-6212 Mass Terminal Each NI USB-6212 Mass Terminal requires: 1 Cable, 1 Connector Block	780169-01	Cable: Shielded - SH68-68-EPM Cable (1m)	199006-01
		Connector Block: Screw Terminals - SCC-68	779475-01
NI USB-6216			
NI USB-6216 Mass Terminal Each NI USB-6216 Mass Terminal requires: 1 Cable, 1 Connector Block	780170-01	Cable: Shielded - SH68-68-EPM Cable (1m)	199006-01
		Connector Block: Screw Terminals - SCC-68	779475-01
NI USB-6211			
NI USB-6211 (Windows)	779676-01	No accessories required.	
NI USB-6211 (Mac OS X and Linux)	780104-01	No accessories required.	
NI USB-6218			
NI USB-6218 (Windows)	779678-01	No accessories required.	
NI USB-6218 (Mac OS X and Linux)	780106-01	No accessories required.	
NI USB-6215			
NI USB-6215	779677-01	No accessories required.	
NI USB-6215 (Mac OS X and Linux)	780105-01	No accessories required.	
NI USB-6210			
NI USB-6210 (Windows)	779675-01	No accessories required.	
NI USB-6210 (Mac OS X and Linux)	780103-01	No accessories required.	

Software Recommendations

NI Measurement Studio Professional Edition

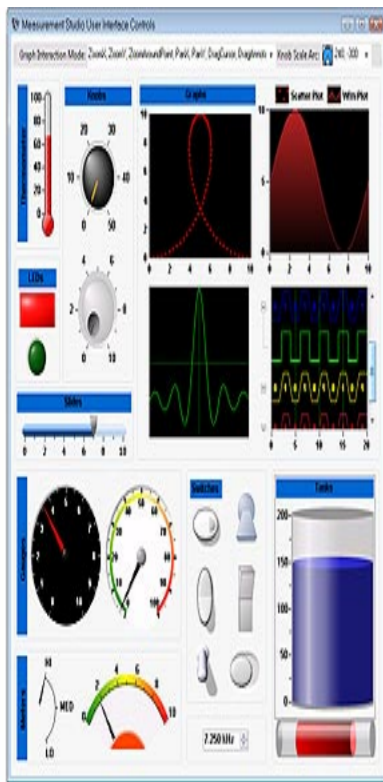

- Base analysis and instrumentation components for Microsoft Visual Basic, Visual C#, and Visual C++
- Cross-platform communication with network variables
- Scientific user interface controls
- Code-generating DAQ Assistant and Instrument I/O Assistant
- Acquire data from GPIB, serial, Ethernet, and plug-in data acquisition devices
- Requires Microsoft Visual Studio 2008/2005/.NET 2003 or Visual Studio 6.0

NI LabWindows™/CVI for Windows

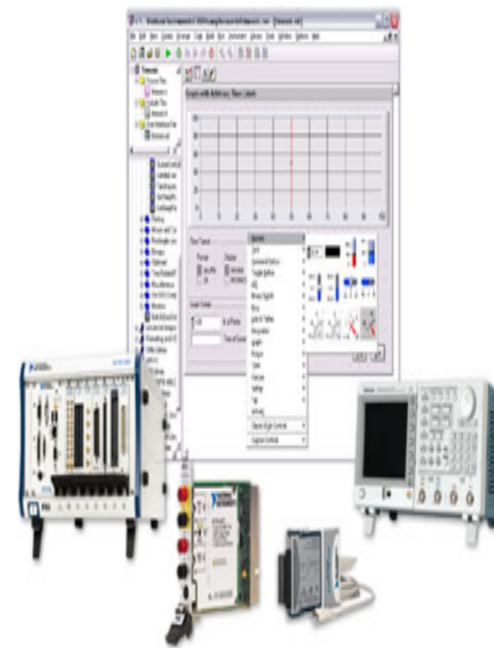

- Real-time advanced 2D graphs and charts with support for Windows Vista/XP/2000
- Complete hardware compatibility with IVI, VISA, DAQ, GPIB, and serial
- Analysis tools for array manipulation, signal processing statistics, and curve fitting
- Simplified cross-platform communication with network variables
- Measurement Studio .NET tools (included in LabWindows/ CVI Full only)
- The mark LabWindows is used under a license from Microsoft Corporation.

NI LabVIEW SignalExpress for Windows

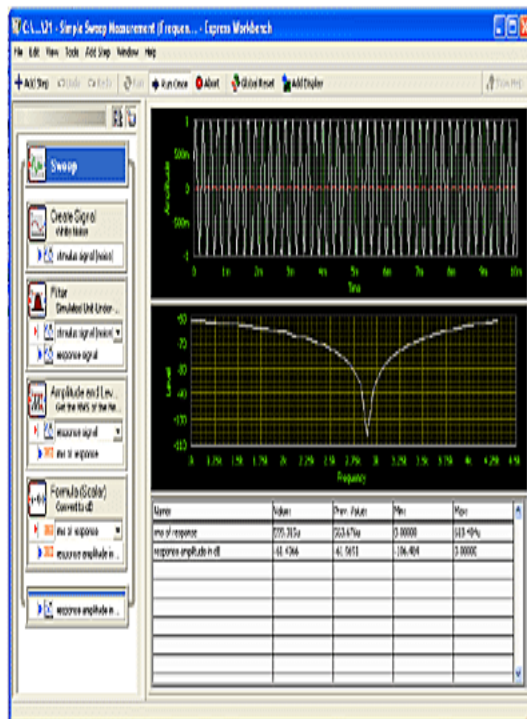

- Quickly configure projects without programming
- Control over 400 PC-based and stand-alone instruments
- Log data from more than 250 data acquisition devices
- Perform basic signal processing, analysis, and file I/O
- Scale your application with automatic LabVIEW code generation
- Create custom reports or easily export data to LabVIEW, DIAdem or Microsoft Excel

Support and Services

Calibration

NI measurement hardware is calibrated to ensure measurement accuracy and verify that the device meets its published specifications. To ensure the ongoing accuracy of your measurement hardware, NI offers basic or detailed recalibration service that provides ongoing ISO 9001 audit compliance and confidence in your measurements. To learn more about NI calibration services or to locate a qualified service center near you, contact your local sales office or visit ni.com/calibration.

Technical Support

Get answers to your technical questions using the following National Instruments resources.

- **Support** - Visit ni.com/support to access the NI KnowledgeBase, example programs, and tutorials or to contact our applications engineers who are located in NI sales offices around the world and speak the local language.
- **Discussion Forums** - Visit forums.ni.com for a diverse set of discussion boards on topics you care about.
- **Online Community** - Visit community.ni.com to find, contribute, or collaborate on customer-contributed technical content with users like you.

Repair

While you may never need your hardware repaired, NI understands that unexpected events may lead to necessary repairs. NI offers repair services performed by highly trained technicians who quickly return your device with the guarantee that it will perform to factory specifications. For more information, visit ni.com/repair.

Training and Certifications

The NI training and certification program delivers the fastest, most certain route to increased proficiency and productivity using NI software and hardware. Training builds the skills to more efficiently develop robust, maintainable applications, while certification validates your knowledge and ability.

- **Classroom training in cities worldwide** - the most comprehensive hands-on training taught by engineers.
- **On-site training at your facility** - an excellent option to train multiple employees at the same time.
- **Online instructor-led training** - lower-cost, remote training if classroom or on-site courses are not possible.
- **Course kits** - lowest-cost, self-paced training that you can use as reference guides.
- **Training memberships** and training credits - to buy now and schedule training later.

Visit ni.com/training for more information.

Extended Warranty

NI offers options for extending the standard product warranty to meet the life-cycle requirements of your project. In addition, because NI understands that your requirements may change, the extended warranty is flexible in length and easily renewed. For more information, visit ni.com/warranty.

OEM

NI offers design-in consulting and product integration assistance if you need NI products for OEM applications. For information about special pricing and services for OEM customers, visit ni.com/oem.

Alliance

Our Professional Services Team is comprised of NI applications engineers, NI Consulting Services, and a worldwide National Instruments Alliance Partner program of more than 600 independent consultants and integrators. Services range from start-up assistance to turnkey system integration. Visit ni.com/alliance.

[Back to Top](#)

Detailed Specifications

Specifications listed below are typical at 25 °C unless otherwise noted. Refer to the NI USB-621x User Manual for more information about USB-621x devices.

Analog Input

Number of channels

USB-6210/6211/6212/6215/6216	8 differential or 16 single ended
USB-6218	16 differential or 32 single ended
ADC resolution	16 bits
DNL	No missing codes guaranteed
INL	Refer to the AI Absolute Accuracy Tables
Sampling rate	
Maximum	
USB-6210/6211/6215/6218	250 kS/s single channel, 250 kS/s multichannel (aggregate)
USB-6212/6216	400 kS/s single channel, 400 kS/s multichannel (aggregate)
Minimum	0 S/s
Timing accuracy	50 ppm of sample rate
Timing resolution	50 ns
Input coupling	DC
Input range	± 10 V, ± 5 V, ± 1 V, ± 0.2 V
Maximum working voltage for analog inputs (signal + common mode)	± 10.4 V of AI GND
CMRR (DC to 60 Hz)	100 dB
Input impedance	
Device on	
AI+ to AI GND	>10 G Ω in parallel with 100 pF
AI- to AI GND	>10 G Ω in parallel with 100 pF
Device off	
AI+ to AI GND	1200 Ω
AI- to AI GND	1200 Ω
Input bias current	± 100 pA
Crosstalk (at 100 kHz)	

Adjacent channels	-75 dB
Non-adjacent channels	-90 dB
Small signal bandwidth (-3 dB)	
USB-6210/6211/6215/6218	450 kHz
USB-6212/6216	1.5 MHz
Input FIFO size	4,095 samples
Scan list memory	4,095 entries
Data transfers	USB Signal Stream, programmed I/O
Overvoltage protection (AI <0..31>, AI SENSE)	
Device on	±30 V for up to two AI pins
Device off	±20 V for up to two AI pins
Input current during overvoltage condition	±20 mA max/AI pin

Settling Time for Multichannel Measurements

Accuracy, full scale step, all ranges

USB-6210/6211/6215/6218	
±90 ppm of step (±6 LSB)	4 µs convert interval
±30 ppm of step (±2 LSB)	5 µs convert interval
±15 ppm of step (±1 LSB)	7 µs convert interval
USB-6212/6216	
±90 ppm of step (±6 LSB)	2.5 µs convert interval
±30 ppm of step (±2 LSB)	3.5 µs convert interval
±15 ppm of step (±1 LSB)	5.5 µs convert interval

Typical Performance Graphs

USB-6210/6211/6215/6218
Settling Error Versus Time for Different Source Impedances

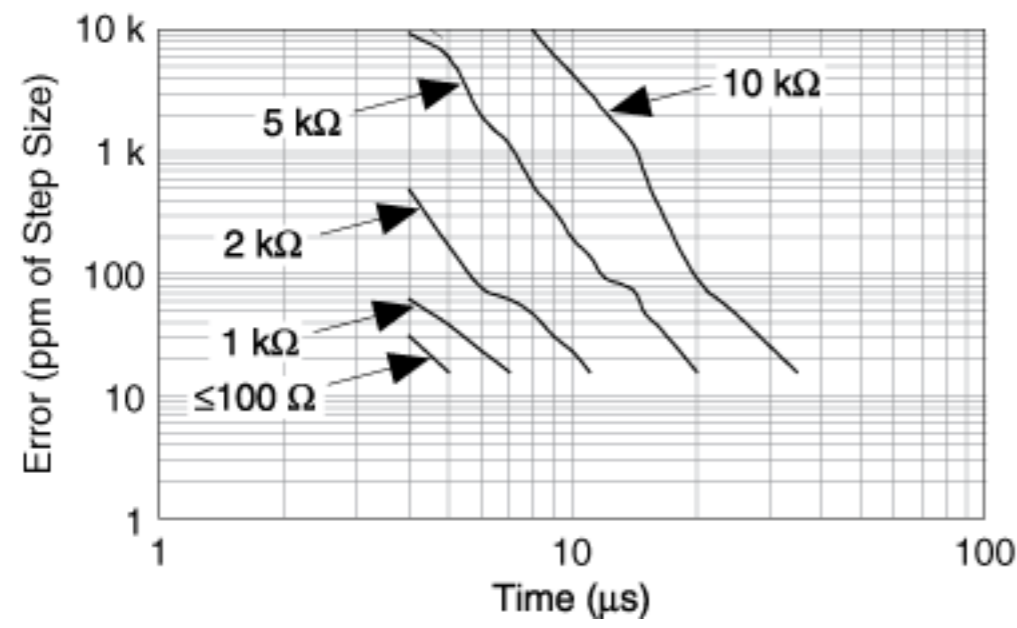

USB-6212/6216
Settling Error Versus Time for Different Source Impedances

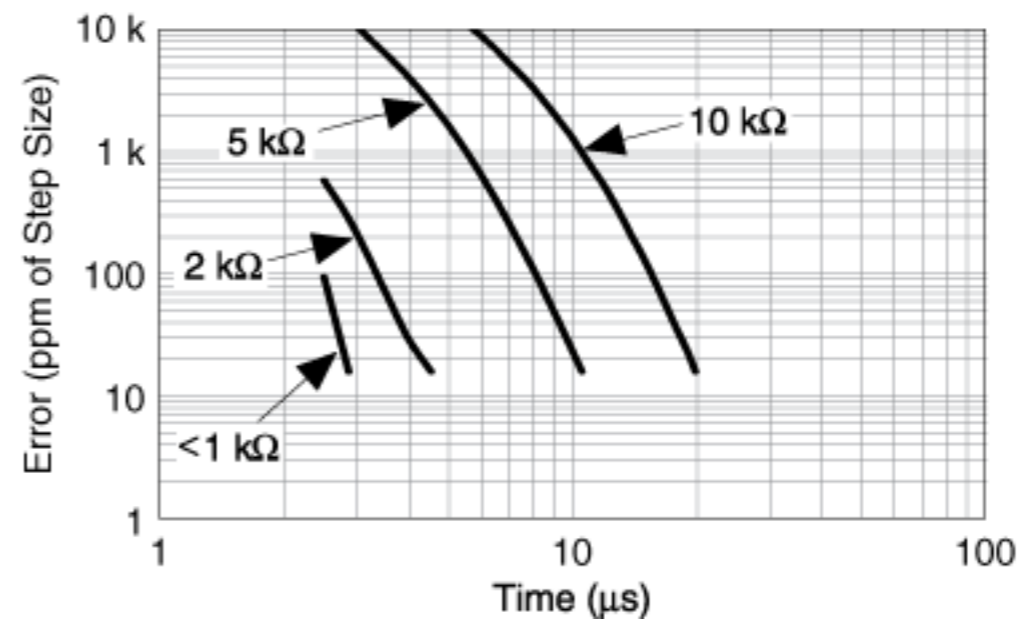

AI <0..31> CMRR

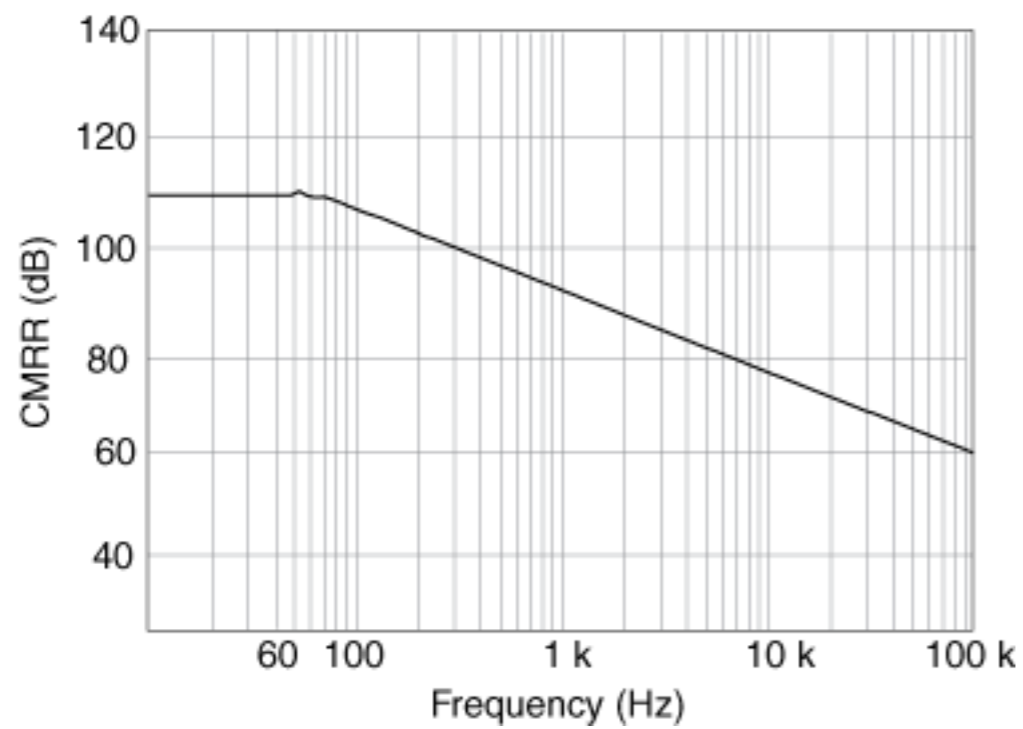

Analog Output

Number of channels

USB-6210	0
----------	---

USB-6211/6212/6215/6216/6218	2
------------------------------	---

DAC resolution	16 bits
----------------	---------

DNL	±1 LSB
-----	--------

Monotonicity	16 bit guaranteed
--------------	-------------------

Maximum update rate

1 channel	250 kS/s
-----------	----------

2 channels	250 kS/s per channel
------------	----------------------

Timing accuracy	50 ppm of sample rate
-----------------	-----------------------

Timing resolution	50 ns
-------------------	-------

Output range	±10 V
--------------	-------

Output coupling	DC
-----------------	----

Output impedance	0.2 Ω
------------------	-------

Output current drive	±2 mA
----------------------	-------

Overdrive protection	±30 V
----------------------	-------

Overdrive current	2.4 mA
Power-on state	±20 mV
Power-on glitch	±1 V for 200 ms
Output FIFO size	8,191 samples shared among channels used
Data transfers	USB Signal Stream, programmed I/O
AO waveform modes:	
<ul style="list-style-type: none"> • Non-periodic waveform • Periodic waveform regeneration mode from onboard FIFO • Periodic waveform regeneration from host buffer including dynamic update 	
Settling time, full scale step 15 ppm (1 LSB)	32 μs
Slew rate	5 V/μs
Glitch energy	
Magnitude	100 mV
Duration	2.6 μs
Calibration (AI and AO)	
Recommended warm-up time	15 minutes
Calibration interval	1 year

AI Absolute Accuracy Table (USB-6210/6211/6215/6218)

Nominal Range		Residual Gain Error (ppm of Reading)	Gain Tempco (ppm/°C)	Reference Tempco	Residual Offset Error (ppm of Range)	Offset Tempco (ppm of Range/°C)	INL Error (ppm of Range)	Random Noise, σ (μVrms)	Absolute Accuracy at Full Scale ¹ (μV)	Sensitivity ² (μV)
Positive Full Scale	Negative Full Scale									
10	-10	75	7.3	5	20	34	76	229	2,690	91.6
5	-5	85	7.3	5	20	36	76	118	1,410	47.2
1	-1	95	7.3	5	25	49	76	26	310	10.4
0.2	-0.2	135	7.3	5	40	116	76	12	88	4.8

AbsoluteAccuracy = Reading · (GainError) + Range · (OffsetError) + NoiseUncertainty

GainError = ResidualAIGainError + GainTempco · (TempChangeFromLastInternalCal) + ReferenceTempco · (TempChangeFromLastExternalCal)

OffsetError = ResidualAIOffsetError + OffsetTempco · (TempChangeFromLastInternalCal) + INL_Error

$$\text{NoiseUncertainty} = \frac{\text{RandomNoise} \cdot 3}{\sqrt{100}} \quad \text{For a coverage factor of } 3 \sigma \text{ and averaging 100 points.}$$

¹ Absolute accuracy at full scale on the analog input channels is determined using the following assumptions:

TempChangeFromLastExternalCal = 10 °C

TempChangeFromLastInternalCal = 1 °C

number_of_readings = 100

CoverageFactor = 3 σ

For example, on the 10 V range, the absolute accuracy at full scale is as follows:

GainError = 75 ppm + 7.3 ppm · 1 + 5 ppm · 10 GainError = 132 ppm

OffsetError = 20 ppm + 34 ppm · 1 + 76 ppm OffsetError = 130 ppm

$$\text{NoiseUncertainty} = \frac{229 \mu\text{V} \cdot 3}{\sqrt{100}} \quad \text{NoiseUncertainty} = 68.7 \mu\text{V}$$

AbsoluteAccuracy = 10 V · (GainError) + 10 V · (OffsetError) + NoiseUncertainty AbsoluteAccuracy = 2,690 μV

² Sensitivity is the smallest voltage change that can be detected. It is a function of noise.

Accuracies listed are valid for up to one year from the device external calibration.

AI Absolute Accuracy Table (USB-6212/6216)

Nominal Range		Residual Gain Error (ppm of Reading)	Gain Tempco (ppm/°C)	Reference Tempco	Residual Offset Error (ppm of Range)	Offset Tempco (ppm of Range/°C)	INL Error (ppm of Range)	Random Noise, σ (μVrms)	Absolute Accuracy at Full Scale ¹ (μV)	Sensitivity ² (μV)
Positive Full Scale	Negative Full Scale									
10	-10	75	7.3	5	20	34	76	295	2,710	118.0
5	-5	85	7.3	5	20	36	76	149	1,420	59.6
1	-1	95	7.3	5	25	49	76	32	310	12.8
0.2	-0.2	135	7.3	5	40	116	76	13	89	5.2

AbsoluteAccuracy = Reading · (GainError) + Range · (OffsetError) + NoiseUncertainty

GainError = ResidualAIGainError + GainTempco · (TempChangeFromLastInternalCal) + ReferenceTempco · (TempChangeFromLastExternalCal)

OffsetError = ResidualAIOffsetError + OffsetTempco · (TempChangeFromLastInternalCal) + INL_Error

$$\text{NoiseUncertainty} = \frac{\text{RandomNoise} \cdot 3}{\sqrt{100}} \quad \text{For a coverage factor of } 3 \sigma \text{ and averaging 100 points.}$$

¹ Absolute accuracy at full scale on the analog input channels is determined using the following assumptions:

TempChangeFromLastExternalCal = 10 °C

TempChangeFromLastInternalCal = 1 °C

number_of_readings = 100

CoverageFactor = 3 σ

For example, on the 10 V range, the absolute accuracy at full scale is as follows:

GainError = 75 ppm + 7.3 ppm · 1 + 5 ppm · 10 GainError = 132 ppm

OffsetError = 20 ppm + 34 ppm · 1 + 76 ppm OffsetError = 130 ppm

$$\text{NoiseUncertainty} = \frac{295 \mu\text{V} \cdot 3}{\sqrt{100}} \quad \text{NoiseUncertainty} = 88.5 \mu\text{V}$$

AbsoluteAccuracy = 10 V · (GainError) + 10 V · (OffsetError) + NoiseUncertainty AbsoluteAccuracy = 2,690 μV

² Sensitivity is the smallest voltage change that can be detected. It is a function of noise.

Accuracies listed are valid for up to one year from the device external calibration.

AO Absolute Accuracy Table										
Nominal Range		Residual Gain Error (ppm of Reading)	Gain Tempco (ppm/°C)	Reference Tempco	Residual Offset Error (ppm of Range)	Offset Tempco (ppm of Range/°C)	INL Error (ppm of Range)	Random Noise, σ (μ Vrms)	Absolute Accuracy at Full Scale ¹ (μ V)	Sensitivity ² (μ V)
Positive Full Scale	Negative Full Scale									
10	-10	90	11	5	60	12	128	3,512	2,710	118.0

¹ Absolute Accuracy at full scale numbers is valid immediately following internal calibration and assumes the device is operating within 10 °C of the last external calibration. Accuracies listed are valid for up to one year from the device external calibration.

AbsoluteAccuracy = OutputValue · (GainError) + Range · (OffsetError)

GainError = ResidualGainError + GainTempco · (TempChangeFromLastInternalCal) + ReferenceTempco · (TempChangeFromLastExternalCal)

OffsetError = ResidualOffsetError + AOffsetTempco · (TempChangeFromLastInternalCal) + INL_Error

Digital I/O/PFI

Static Characteristics

Number of channels

Digital input

USB-6210/6211/6215

4 (PFI <0..3>/P0.<0..3>)

USB-6218

8 (PFI <0..3>/P0.<0..3>, PFI <8..11>/P0.<4..7>)

Digital output

USB-6210/6211/6215

4 (PFI <4..7>/P1.<0..3>)

USB-6218

8 (PFI <4..7>/P1.<0..3>, PFI <12..15>/P1.<4..7>)

Digital input or output

USB-6212/6216 Screw Termination

32 total, 16 (P0.<0..15>), 16 (PFI <0..7>/P1.<0..7>, PFI <8..15>/P2.<0..7>)

USB-6212/6216 Mass Termination

24 total, 8 (P0.<0..7>), 16 (PFI <0..7>/P1.<0..7>, PFI <8..15>/P2.<0..7>)

Ground reference

D GND

Pull-down resistor

USB-6210/6211/6215/6218

47 k Ω \pm 1%

USB-6212/6216

50 k Ω typical, 20 k Ω minimum

Input voltage protection¹

\pm 20 V on up to 8 pins

PFI Functionality

USB-6210/6211/6215/6218

PFI <0..3>, PFI <8..11>/Port 0

Functionality

Static digital input, timing input

Debounce filter settings

125 ns, 6.425 μ s, 2.56 ms, disable; high and low transitions; selectable per input

PFI <4..7>, PFI <12..15>/Port 1

Functionality

Static digital output, timing output

Timing output sources

Many AI, AO, counter timing signals

USB-6212/6216 PFI <0..15>

Functionality

Static digital input, static digital output, timing input, timing output

Timing output sources

Many AI, AO, counter timing signals

Debounce filter settings

125 ns, 6.425 μ s, 2.56 ms, disable; high and low transitions; selectable per input

Maximum Operation Conditions		
Level	Min	Max
I_{OL} output low current	—	16 mA
I_{OH} output high current	—	-16 mA

Digital Input Characteristics (USB-6210/6211/6215/6218)		
Level	Min	Max
V_{IL} input low voltage	0 V	0.8 V
V_{IH} input high voltage	2 V	5.25 V
I_{in}^L input low current ($V_{in} = 0$ V)	—	-10 μ A
I_{in}^H input high current ($V_{in} = 5$ V)	—	120 μ A

Digital Input Characteristics (USB-6212/6216)		
Level	Min	Max
V_{IL} input low voltage	0 V	0.8 V
V_{IH} input high voltage	2.2 V	5.25 V
I_{in}^{L} input low current ($V_{in} = 0$ V)	—	-10 μ A
I_{in}^{H} input high current ($V_{in} = 5$ V)	—	250 μ A
Positive-going threshold (VT+)	—	2.2 V
Negative-going threshold (VT-)	0.8 V	—
Delta VT hysteresis (VT+ - VT-)	0.2 V	—

Digital Output Characteristics (USB-6210/6211/6215/6218)		
Parameter	Voltage Level	Current Level
V_{OL}	0.6 V	6 mA
V_{OH}	2.7 V	-16 mA
	3.8 V	-6 mA

Digital Output Characteristics (USB-6212/6216)

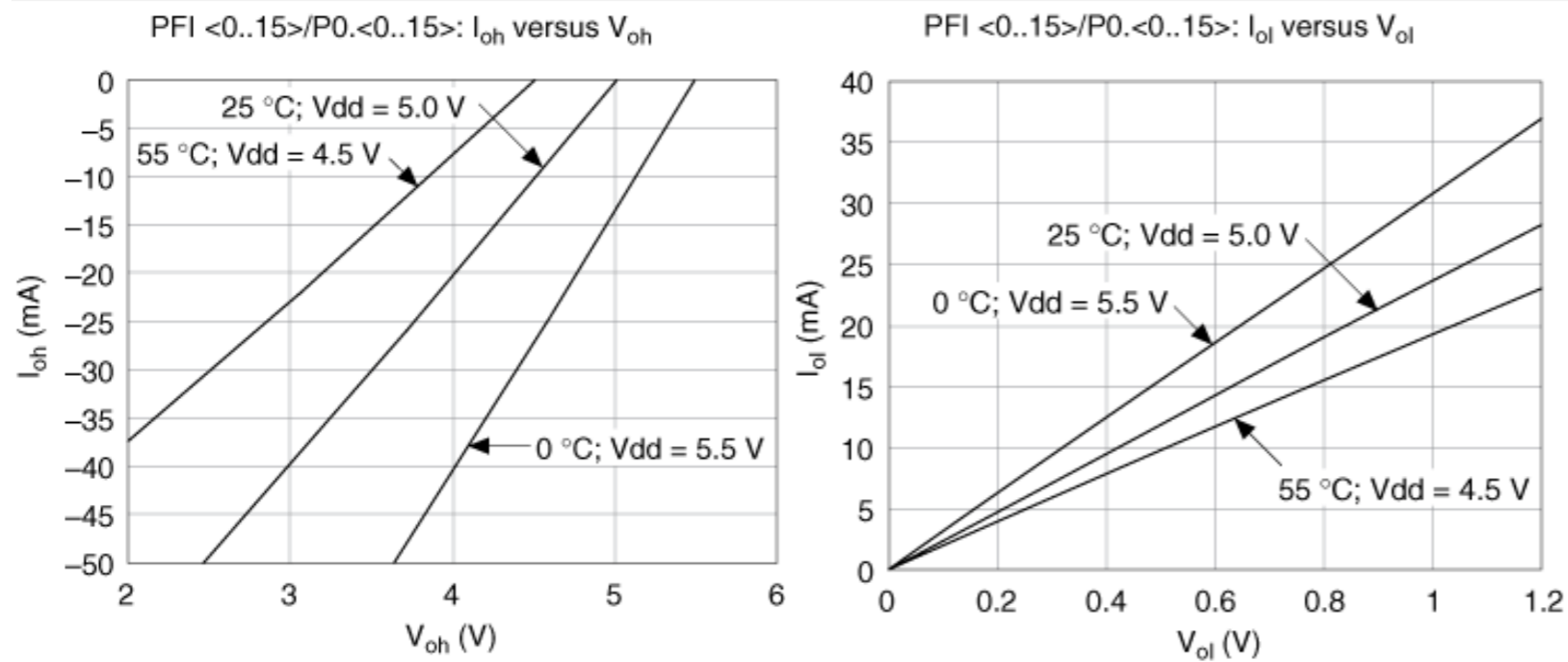

General-Purpose Counter/Timers

Number of counter/timers	2
Resolution	32 bits
Counter measurements	Edge counting, pulse, semi-period, period, two-edge separation
Position measurements	X1, X2, X4 quadrature encoding with Channel Z reloading; two-pulse encoding
Output applications	Pulse, pulse train with dynamic updates, frequency division, equivalent time sampling
Internal base clocks	80 MHz, 20 MHz, 0.1 MHz
External base clock frequency	0 MHz to 20 MHz
Base clock accuracy	50 ppm
Inputs	Gate, Source, HW_Arm, Aux, A, B, Z, Up_Down
Routing options for inputs	
USB-6210/6211/6215/6218	PFI <0..3>, PFI <8..11>, many internal signals
USB-6212/6216	PFI <0..15>, many internal signals
FIFO	1,023 samples
Data transfers	USB Signal Stream, programmed I/O

Frequency Generator

Number of channels	1
Base clocks	10 MHz, 100 kHz

Divisors	1 to 16
Base clock accuracy	50 ppm
Output can be available on any output PFI terminal.	

External Digital Triggers

Source	
USB-6210/6211/6215/6218	PFI <0..3>, PFI <8..11>
USB-6212/6216	PFI <0..15>
Polarity	Software-selectable for most signals
Analog input function	Start Trigger, Reference Trigger, Pause Trigger, Sample Clock, Convert Clock, Sample Clock Timebase
Analog output function	Start Trigger, Pause Trigger, Sample Clock, Sample Clock Timebase
Counter/timer functions	Gate, Source, HW_Arm, Aux, A, B, Z, Up_Down

Bus Interface

USB	USB 2.0 Hi-Speed or Full-Speed ²
USB Signal Stream (USB)	4, can be used for analog input, analog output, counter/timer 0, counter/timer 1

Power Limits

+5 V terminal as output ^{3,4}	
Voltage	4.6 to 5.2 V
Current (internally limited)	50 mA max, shared with digital outputs
+5 V terminal as input ^{3,4}	
Voltage	4.75 to 5.35 V
Current	350 mA max, self-resetting fus



Caution Do *not* exceed 16 mA per DIO pin.

Protection	±10 V
------------	-------

Power Requirements

Input voltage on USB-621x USB port	4.5 to 5.25 V in configured state
Maximum inrush current	500 mA
No load typical current	320 mA at 4.5 V
Maximum load	
Typical current	400 mA at 4.5 V
Suspend current	260 µA, typical

Physical Characteristics

Enclosure dimensions (includes connectors)	
--	--

USB-621x Screw Terminal	16.9 × 9.4 × 3.1 cm (6.65 × 3.70 × 1.20 in.)
USB-621x Mass Termination	19.3 × 9.4 × 3.1 cm (7.61 × 3.68 × 1.20 in.)

Weight

USB-6210/6211/6212/6215/6216/6218 Screw Terminal	206 g (7.2 oz)
USB-6212 Mass Termination	227 g (8.0 oz)
USB-6216 Mass Termination	231 g (8.1 oz)
USB-6210 OEM	73 g (2.5 oz)
USB-6212/6216/6218 OEM	76 g (2.6 oz)

I/O connectors

USB-6210/6211/6215	Two 16-position combicon
USB-6212/6216/6218 Screw Terminal	Four 16-position combicon
USB-6212/6216 Mass Termination	One 68-pin SCSI

USB connector	Series B receptacle
---------------	---------------------

Screw terminal wiring	Screw terminal wiring
-----------------------	-----------------------

Torque for screw terminals	0.22-0.25 N · m (2.0 -2.2 lb · in.)
----------------------------	-------------------------------------

Environmental

Operating temperature	0 to 45 °C
-----------------------	------------

Storage temperature	-20 to 70 °C
---------------------	--------------

Humidity	10 to 90% RH, noncondensing
----------	-----------------------------

Maximum altitude	2,000 m
------------------	---------

Pollution Degree (indoor use only)	2
------------------------------------	---

Maximum Working Voltage⁵

USB-6210/6211/6212 Rated Voltage

Channel-to-earth ground	11 V, Measurement Category I
-------------------------	------------------------------

 **Caution** Do *not* use for measurements within Categories II, III, or IV.

USB-6215/6216/6218 Rated Voltage

Channel-to-earth ground⁶

Continuous	≤ 30 Vrms/60 VDC, Measurement Category I ⁷
------------	--

Withstand	≤ 840 Vrms/1200 VDC, verified by a 5 s dielectric withstand test
-----------	---

Channel-to-bus⁸

Continuous	≤ 30 Vrms/60 VDC, Measurement Category I ⁷
------------	--

Withstand	≤ 1400 Vrms/1950 VDC, verified by a 5 s dielectric withstand test
-----------	--

Analog channel to AI GND/AO GND (in the USB-6215/6216/6218 Maximum Working Voltage figure, $ V_a - V_c $)	≤ 11 V, Measurement Category I ⁷
---	--

Digital channel to D GND (in the USB-6215/6216/6218 Maximum Working Voltage figure, $V_b - V_c$)	≤ 5.25 V, Measurement Category I ⁷
---	--

 **Caution** This device is rated for Measurement Category I and the voltage across the isolation barrier is limited to no greater than 30 Vrms/60 VDC/42.4 V_{pk} continuous. Do *not* use for measurements within Categories II, III, or IV.

The USB-6215/6216/6218 Maximum Working Voltage figure illustrates the maximum working voltage specifications.

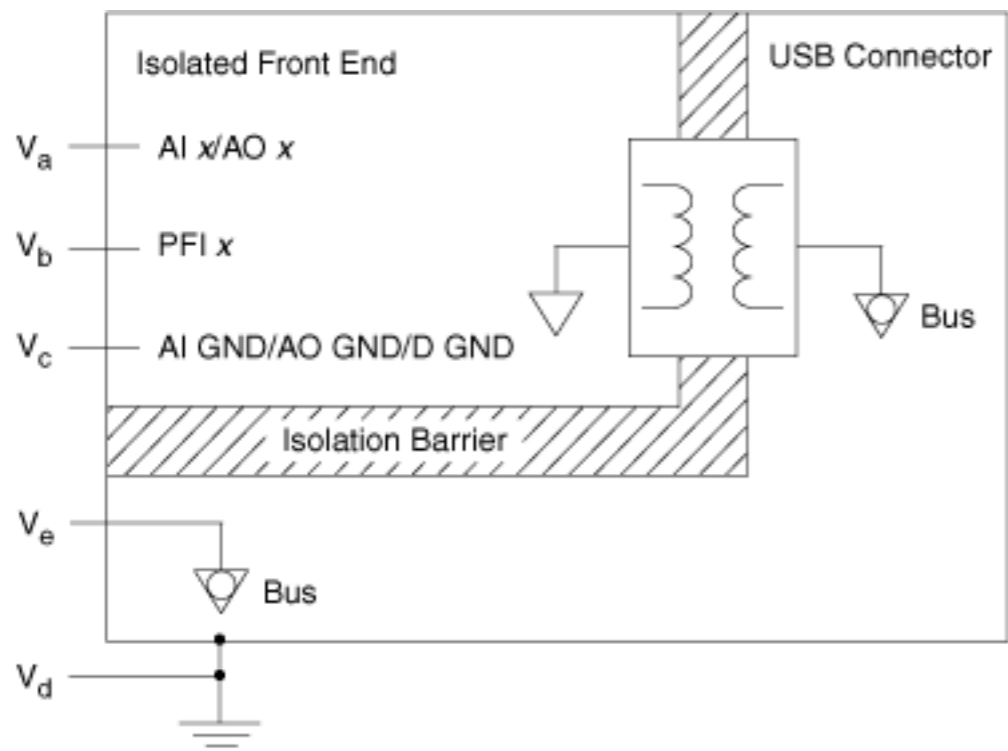

USB-6215/6216/6218 Maximum Working Voltage

Safety

This product is designed to meet the requirements of the following standards of safety for electrical equipment for measurement, control, and laboratory use:

- IEC 61010-1, EN 61010-1
- UL 61010-1, CSA 61010-1

 **Note** For UL and other safety certifications, refer to the product label or visit ni.com/certification, search by model number or product line, and click the appropriate link in the Certification column.

Electromagnetic Compatibility

This product is designed to meet the requirements of the following standards of EMC for electrical equipment for measurement, control, and laboratory use:

- EN 61326 EMC requirements; Minimum Immunity
- EN 55011 Emissions; Group 1, Class A
- CE, C-Tick, ICES, and FCC Part 15 Emissions; Class A

 **Note** For EMC compliance, operate this device with shielded cables.

CE Compliance

This product meets the essential requirements of applicable European Directives, as amended for CE marking, as follows:

- 2006/95/EC; Low-Voltage Directive (safety)
- 2004/108/EC; Electromagnetic Compatibility Directive (EMC)

 **Note** Refer to the Declaration of Conformity (DoC) for this product for any additional regulatory compliance information. To obtain the DoC for this product, visit ni.com/certification, search by model number or product line, and click the appropriate link in the Certification column.

Environmental Management

National Instruments is committed to designing and manufacturing products in an environmentally responsible manner. NI recognizes that eliminating certain hazardous substances from our products is beneficial not only to the environment but also to NI customers.

For additional environmental information, refer to the NI and the Environment Web page at ni.com/environment. This page contains the environmental regulations and directives with which NI complies, as well as other environmental information not included in this document.

Waste Electrical and Electronic Equipment (WEEE)

At the end of their life cycle, all products must be sent to a WEEE recycling center. For more information about WEEE recycling centers and National Instruments WEEE initiatives, visit ni.com/environment/weee.htm.

电子信息产品污染控制管理办法（中国 RoHS）



中国客户 National Instruments 符合中国电子信息产品中限制使用某些有害物质指令 (RoHS)。
关于 National Instruments 中国 RoHS 合规性信息, 请登录 ni.com/environment/rohs_china。
(For information about China RoHS compliance, go to ni.com/environment/rohs_china.)

¹ Stresses beyond those listed under *Input voltage protection* may cause permanent damage to the device.

² If you are using a USB M Series device in Full-Speed mode, device performance will be lower and you will not be able to achieve maximum sampling/update rates.

³ Older revisions of USB-621x Screw Terminal devices have a self-resetting fuse that opens when current exceeds this specification. Newer revisions have a traditional fuse that opens when current exceeds this specification. This fuse is not customer-replaceable; if the fuse permanently opens, return the device to NI for repair.

⁴ USB-621x Mass Termination devices have a user-replaceable socketed fuse that opens when current exceeds this specification. Refer to the *NI USB-621x User*

Manual for information about fuse replacement.

⁵ Maximum working voltage refers to the signal voltage plus the common-mode voltage.

⁶ In the *USB-6215/6216/6218 Maximum Working Voltage* figure, $|V_a - V_d|$, $|V_b - V_d|$, and $|V_c - V_d|$.

⁷ Measurement Category I is for measurements performed on circuits not directly connected to the electrical distribution system referred to as *MAINS* voltage. MAINS is a hazardous live electrical supply system that powers equipment. This category is for measurements of voltages from specially protected secondary circuits. Such voltage measurements include signal levels, special equipment, limited-energy parts of equipment, circuits powered by regulated low-voltage sources, and electronics.

⁸ In the *USB-6215/6216/6218 Maximum Working Voltage* figure, $|V_a - V_e|$, $|V_b - V_e|$, and $|V_c - V_e|$.

[Back to Top](#)

Pinouts/Front Panel Connections

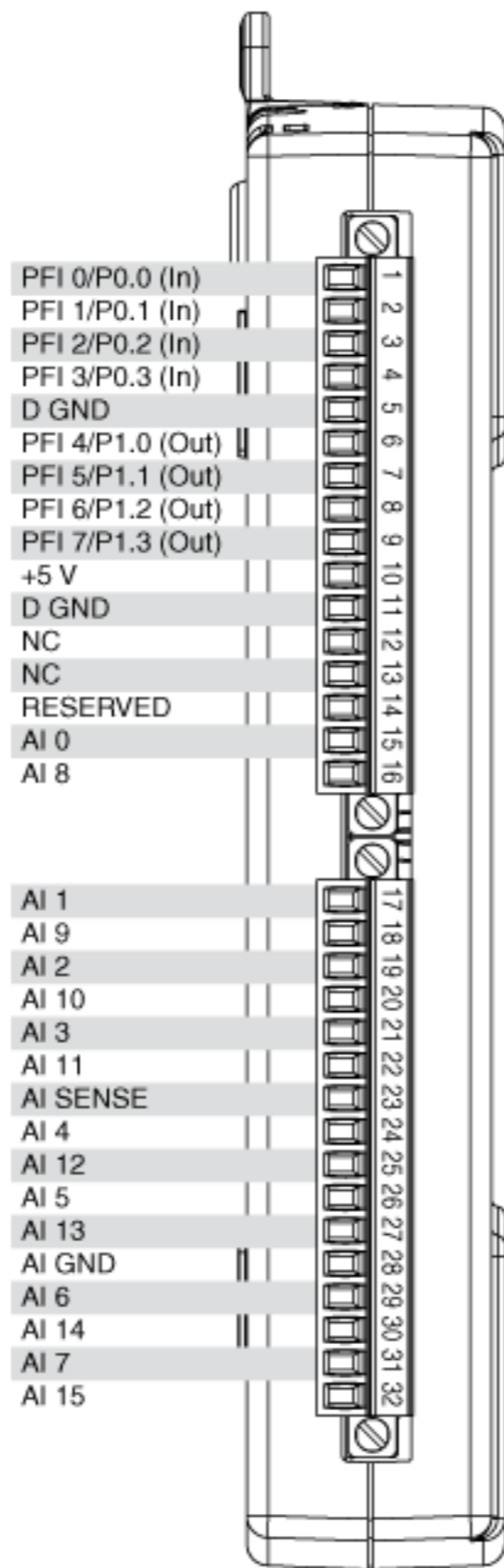

NC = No Connect

USB-6210 Pinout

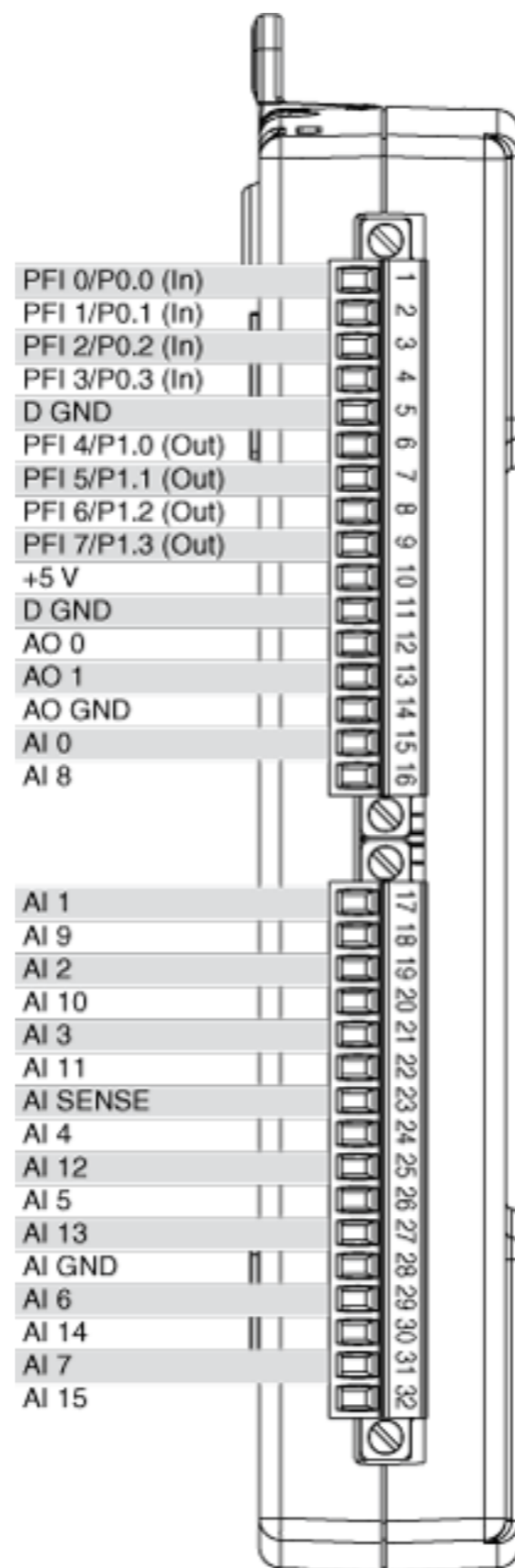

USB-6211/6215 Pinout

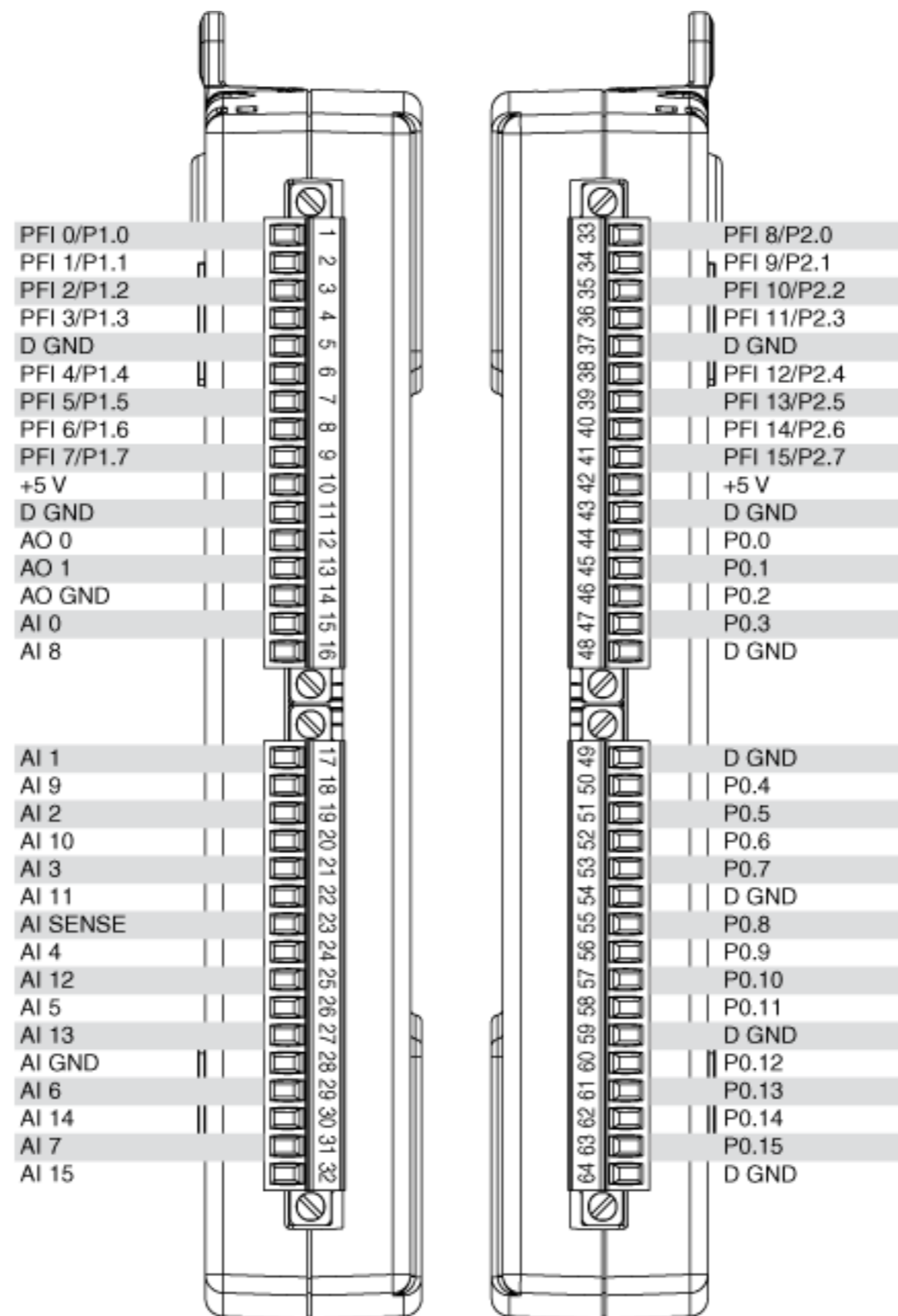

USB-6212/6216 Pinout

AI 8	34	68	AI 0
AI 1	33	67	AI GND
AI GND	32	66	AI 9
AI 10	31	65	AI 2
AI 3	30	64	AI GND
AI GND	29	63	AI 11
AI 4	28	62	AI SENSE
AI GND	27	61	AI 12
AI 13	26	60	AI 5
AI 6	25	59	AI GND
AI GND	24	58	AI 14
AI 15	23	57	AI 7
AO 0	22	56	AI GND
AO 1	21	55	AO GND
NC	20	54	AO GND
P0.4	19	53	D GND
D GND	18	52	P0.0
P0.1	17	51	P0.5
P0.6	16	50	D GND
D GND	15	49	P0.2
+5 V	14	48	P0.7
D GND	13	47	P0.3
D GND	12	46	PFI 11/P2.3
PFI 0/P1.0	11	45	PFI 10/P2.2
PFI 1/P1.1	10	44	D GND
D GND	9	43	PFI 2/P1.2
+5 V	8	42	PFI 3/P1.3
D GND	7	41	PFI 4/P1.4
PFI 5/P1.5	6	40	PFI 13/P2.5
PFI 6/P1.6	5	39	PFI 15/P2.7
D GND	4	38	PFI 7/P1.7
PFI 9/P2.1	3	37	PFI 8/P2.0
PFI 12/P2.4	2	36	D GND
PFI 14/P2.6	1	35	D GND

NC = No Connect

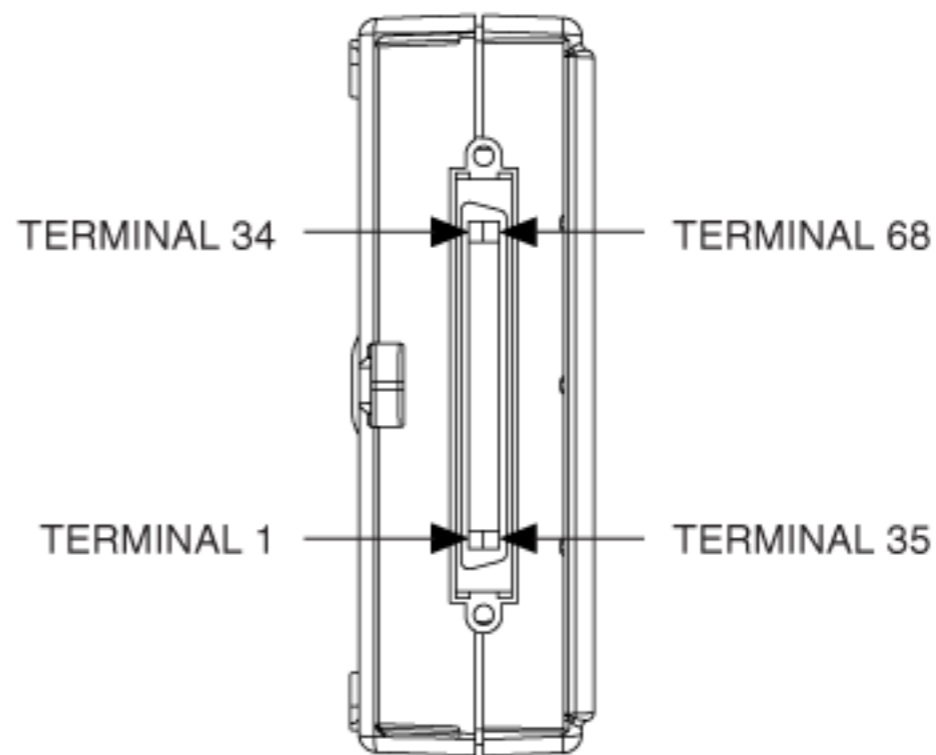

USB-6212/6216 Mass Termination Pinout

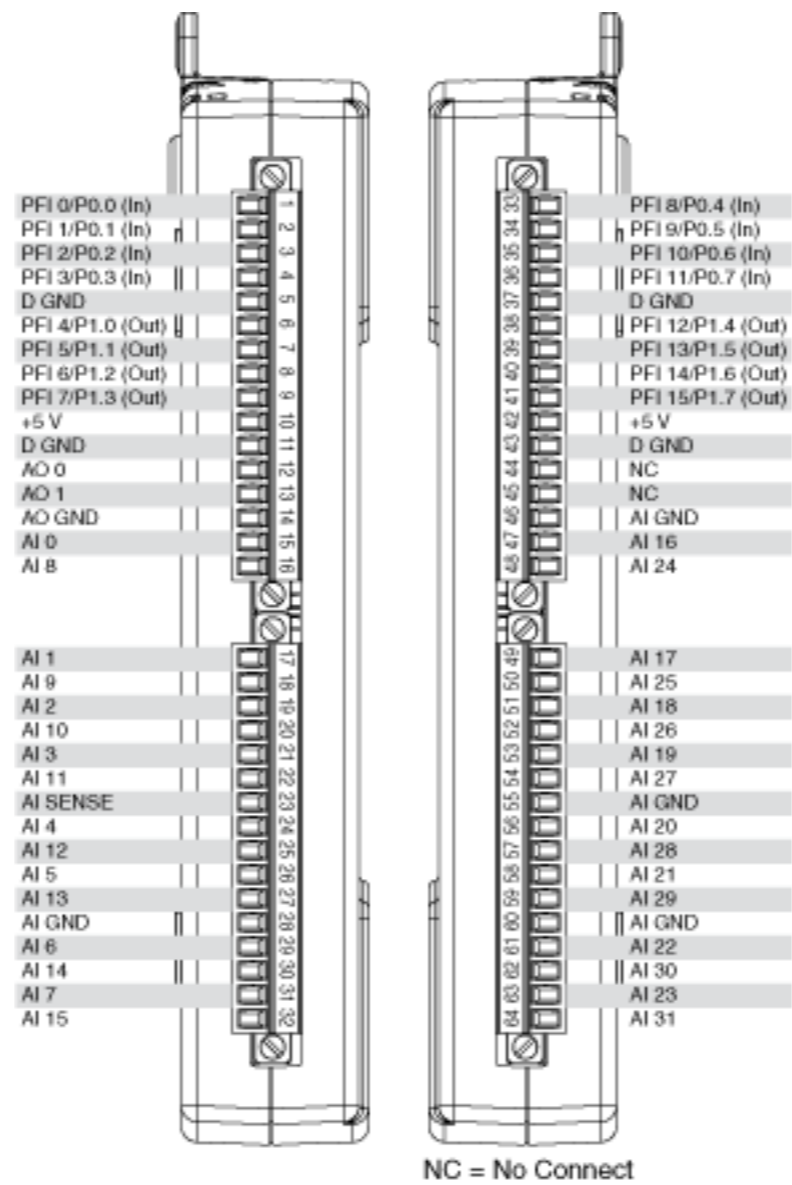

NC = No Connect

USB-6218 Pinout

[Back to Top](#)

©2008 National Instruments. All rights reserved. CVI, DIAdem, LabVIEW, Measurement Studio, National Instruments, National Instruments Alliance Partner, NI, ni.com, NI CompactDAQ, SCXI, and SignalExpress are trademarks of National Instruments. The mark LabWindows is used under a license from Microsoft Corporation. Windows is a registered trademark of Microsoft Corporation in the United States and other countries. Linux® is the registered trademark of Linus Torvalds in the U.S. and other countries. Other product and company names listed are trademarks or trade names of their respective companies. A National Instruments Alliance Partner is a business entity independent from NI and has no agency, partnership, or joint-venture relationship with NI.