

UiO • **University of Oslo**

INF3480

Evolutionary robotics

Kyrre Glette



Today: Evolutionary robotics

- Why evolutionary robotics
- Basics of evolutionary optimization
 - INF3490 will discuss algorithms in detail
- Illustrating examples
 - ROBIN in-house robotic platforms and experiments
- Research challenges
 - Reality gap

Machine intelligence in robotics

- Sensing, vision
 - Gather information about the world and represent it internally for further processing
- Control and planning
 - Low-level control
 - Path planning (arms and mobile robots)
 - Task planning
- Design
 - Robot body shape / structure

Example: Henriette

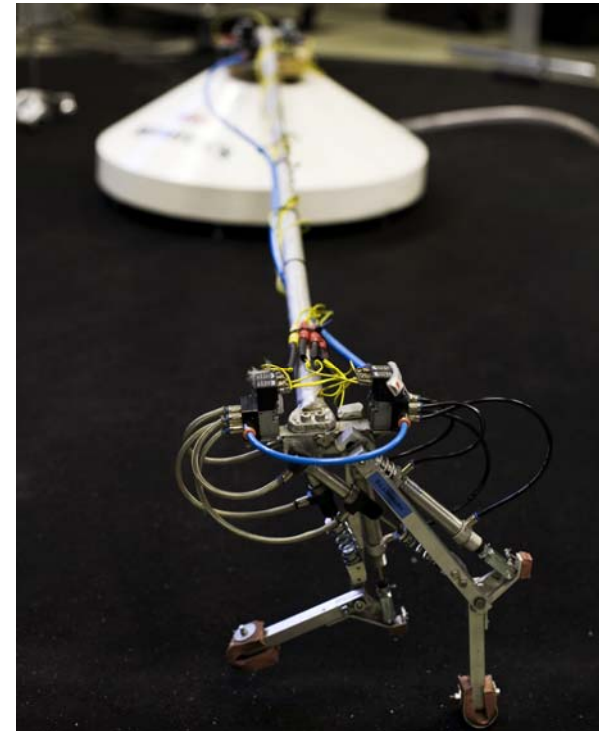

<http://www.youtube.com/watch?v=mXpz5khMY2c>

Current robots

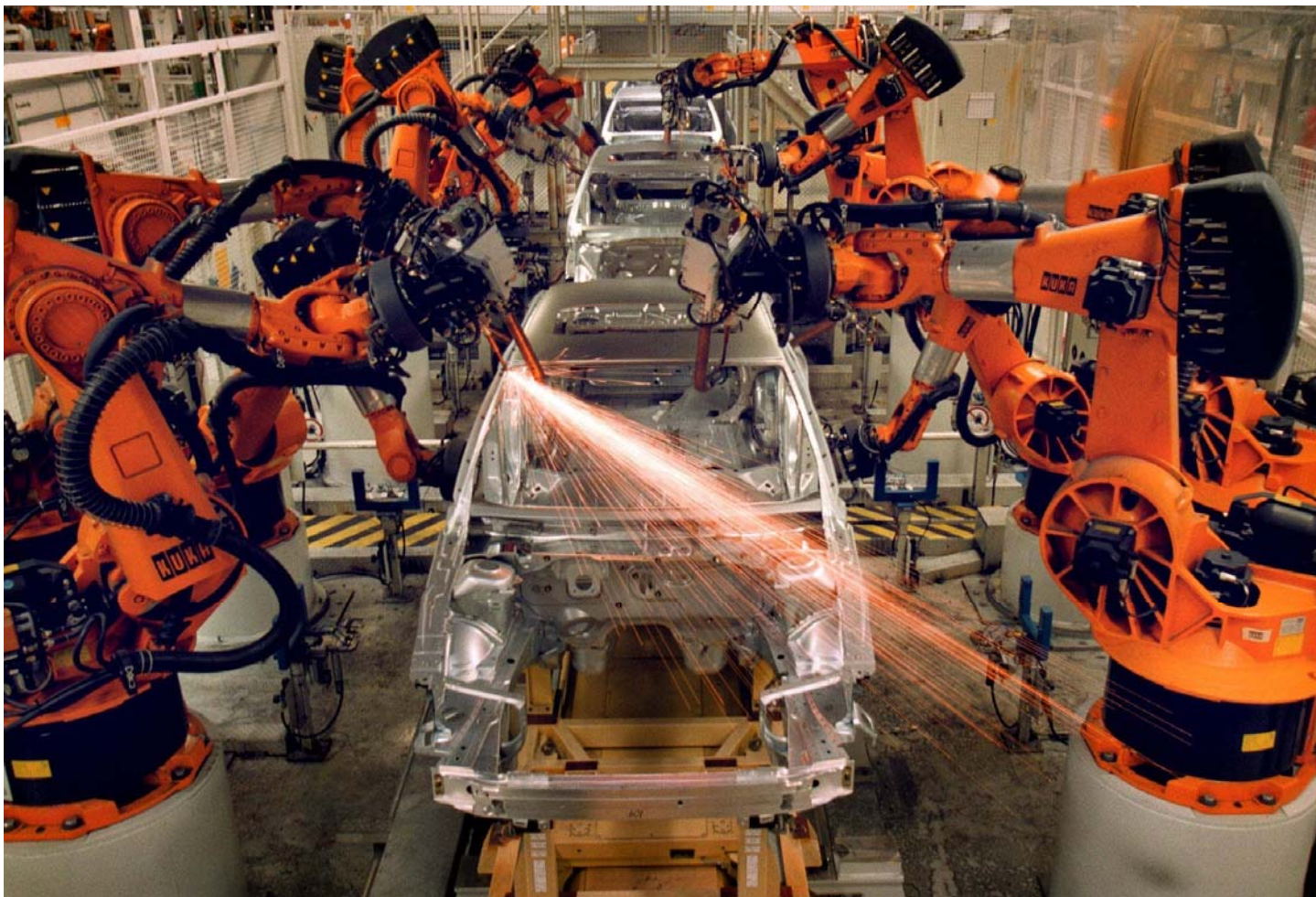

Future scenarios



Future robots

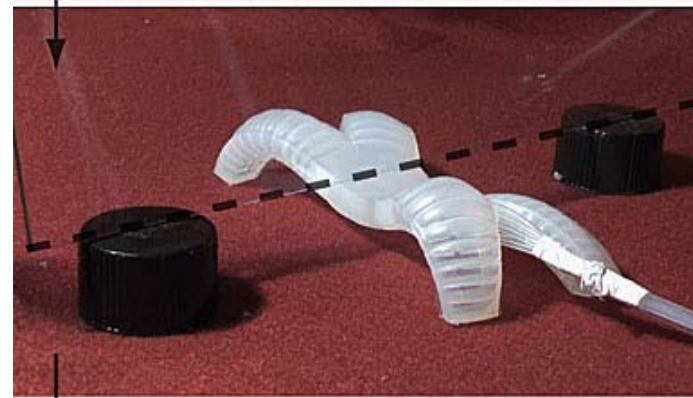
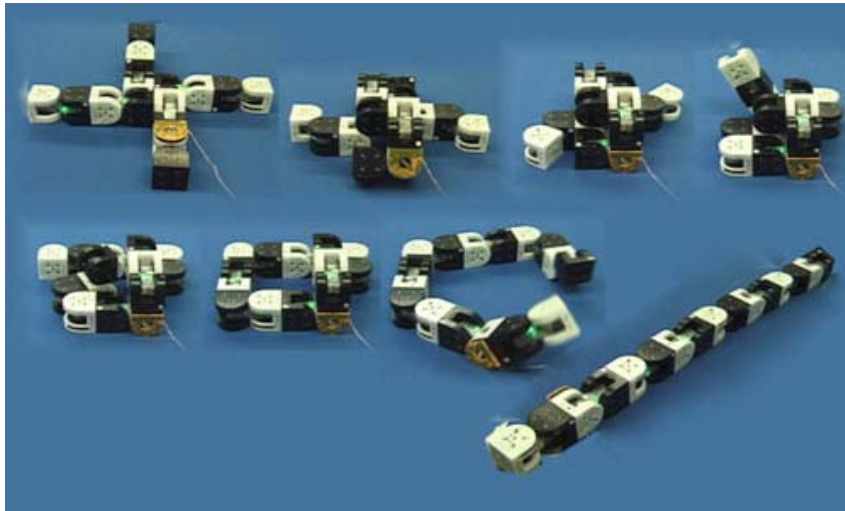

Why evolutionary robotics?

- Adaptation to changes in environment or robot
 - Robot may break or deteriorate
 - Environment may change unexpectedly
- Optimizing for efficiency
 - Energy, speed weight, actuators
- Unconventional, complex designs
 - New materials and actuators make it more challenging with conventional design approaches

Adaptation, optimization, exploration

Henriette: Parameterized control

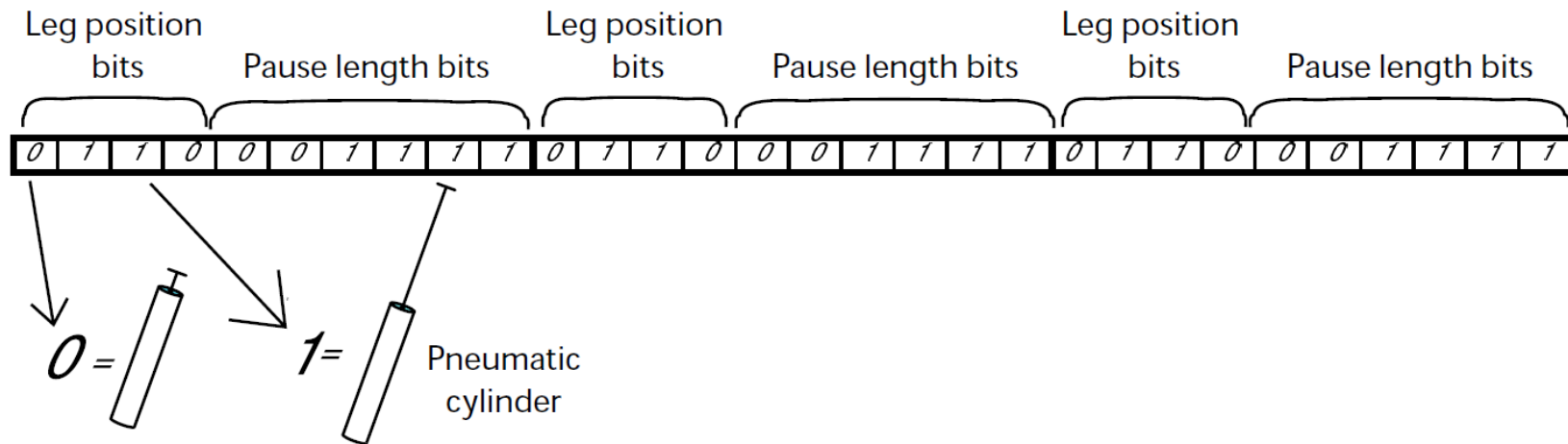

- Walking pattern coded into bit strings.
- 3 “states” consisting of leg configuration and pause length
- An evolutionary algorithm was used to evolve the leg configurations and the pause length.
- For each leg configuration, 4 bits denote the position of 4 actuators, 6 bits denote the length of the pause.
- Total bit string / *genome* length: 30 bits

Evolutionary Algorithm (EA)

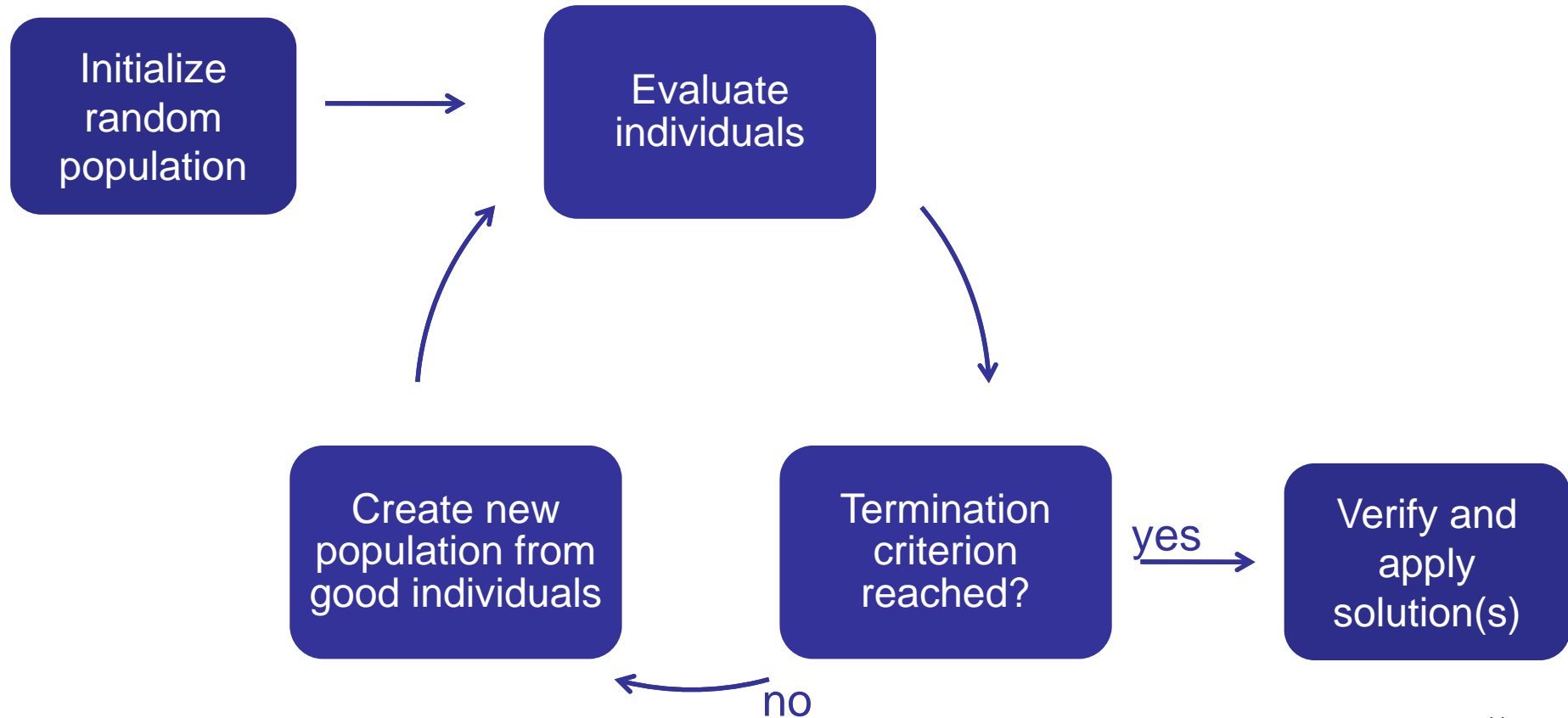

Evolutionary mechanisms

- Selection
 - Good / fit individuals have a higher chance of reproducing
- Inheritance
 - Properties from parents are transferred to offspring
- Variation
 - Changes in the genome adjust the behavior of the offspring, sometimes to the better

Selection

- Each *individual* in a population is evaluated and assigned a *fitness* value, ie. a measure of how a solution performs a given task
 - Example: The forward speed of a robot
 - Henriette: measured by the angular difference from the rotation encoder over 3 repetitions of the sequence
- The probability of an individual being selected for reproduction is proportional to its fitness value (randomness is present)

Inheritance + variation

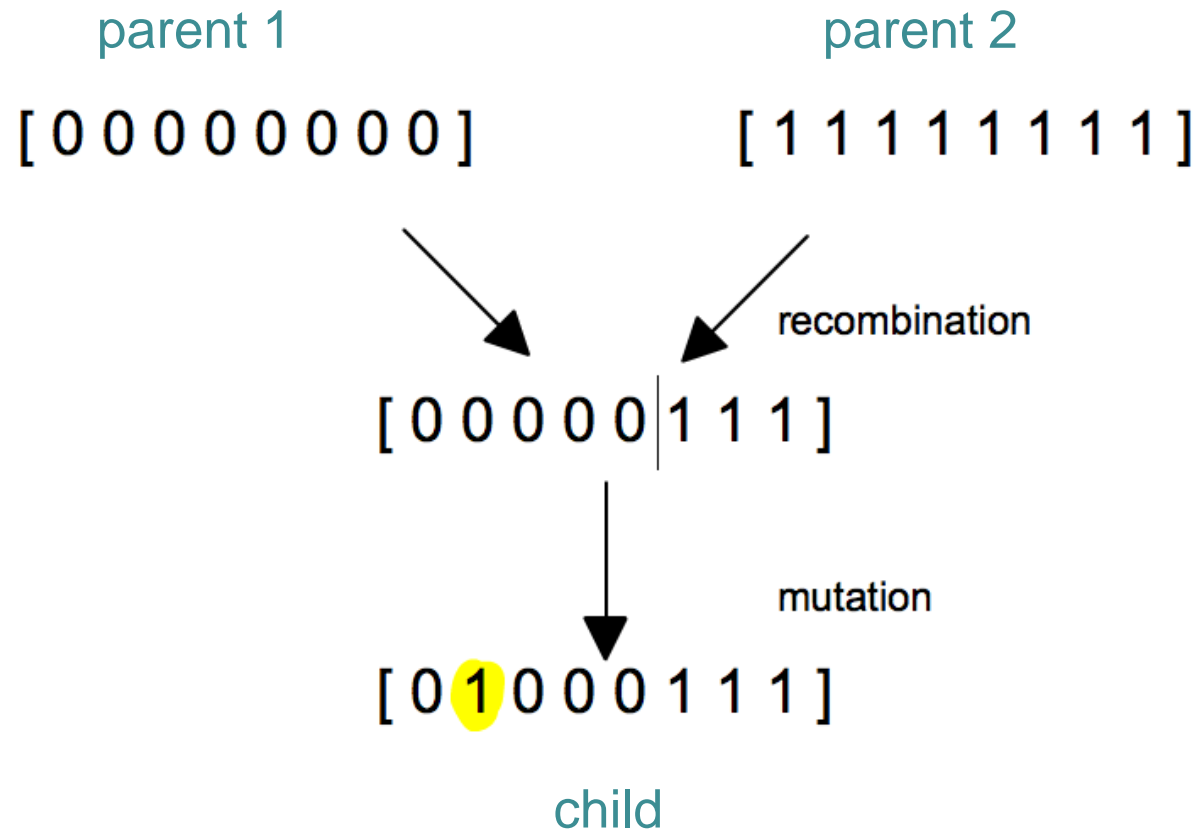

Without bio-terminology, what is an EA?

- A population-based stochastic search algorithm
 - Searching for **satisfactory** solutions in a solution space of all possible solutions
 - Searches in «parallel» on a population of solutions
 - Black-box: does not assume knowledge about the problem (but the results depend on the mapping and fitness function)
- Can handle large search spaces with complex fitness landscape
 - Less chance of being stuck in local optima
- Can give unexpected results



Simulation

- Evolution on a real robot is impractical
 - Time consuming
 - Requires supervision: can get stuck, fall over
 - Mechanical wear
- Simulation should help
 - Allows automated evaluation
 - Can be much faster
 - especially with parallel computation

Example: Quadratot

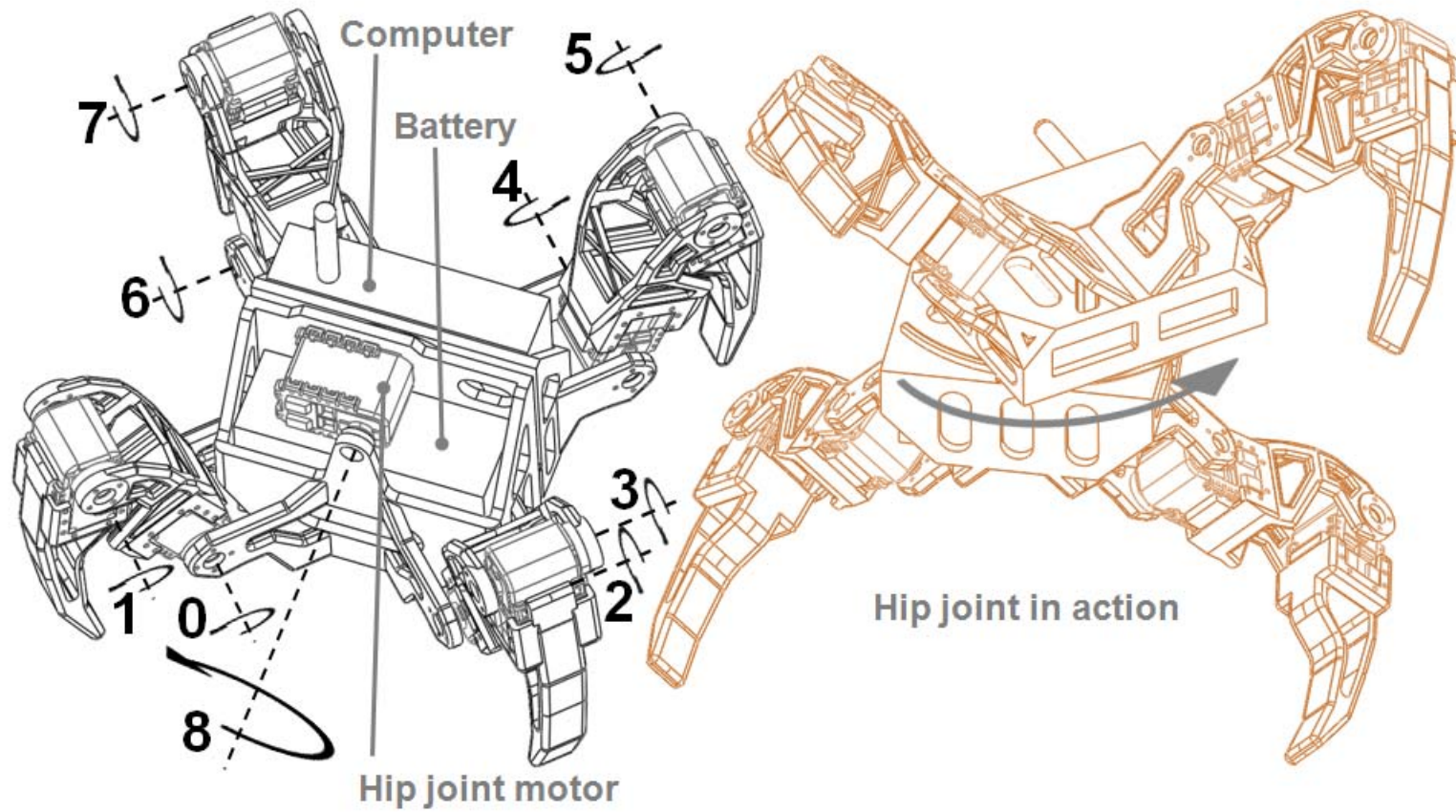

Quadratot: Hardware and model (DEMO)

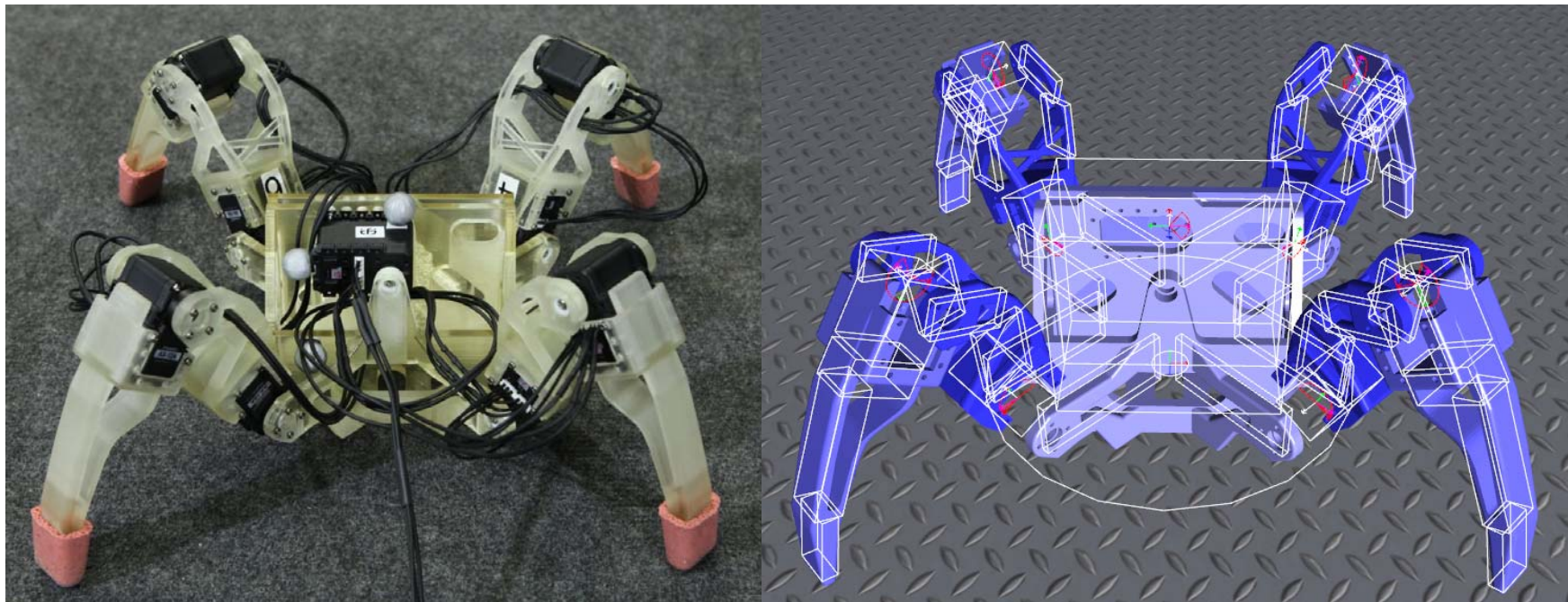

3D printed parts
AX12/18 servos
Silicone rubber socks

NVIDIA PhysX
Revolute motor joints
Rigid bodies (boxes)

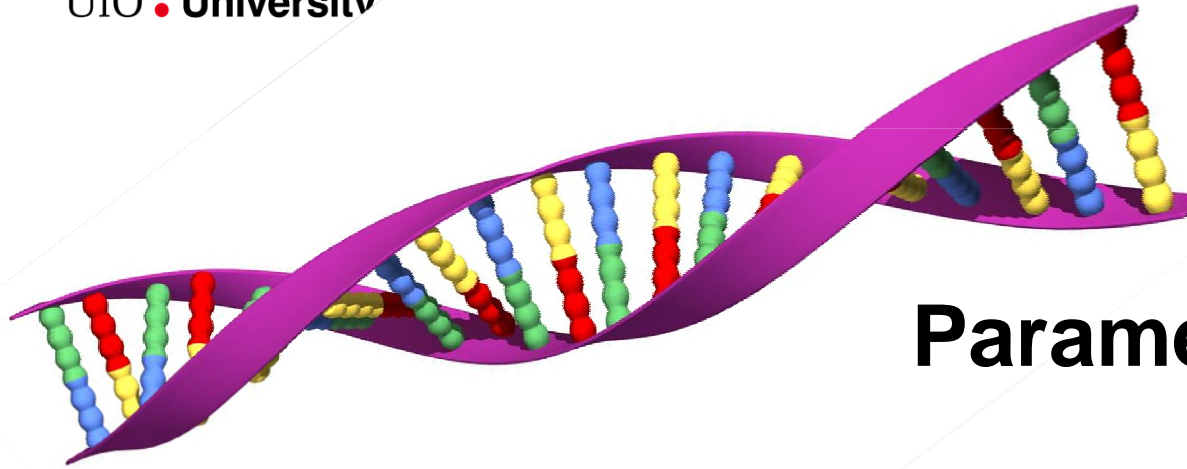

Quadratrot: Parameterized control (mapping)

For each joint:

- Curve shape parameters (4)
- Phase
- Amplitude
- Center angle

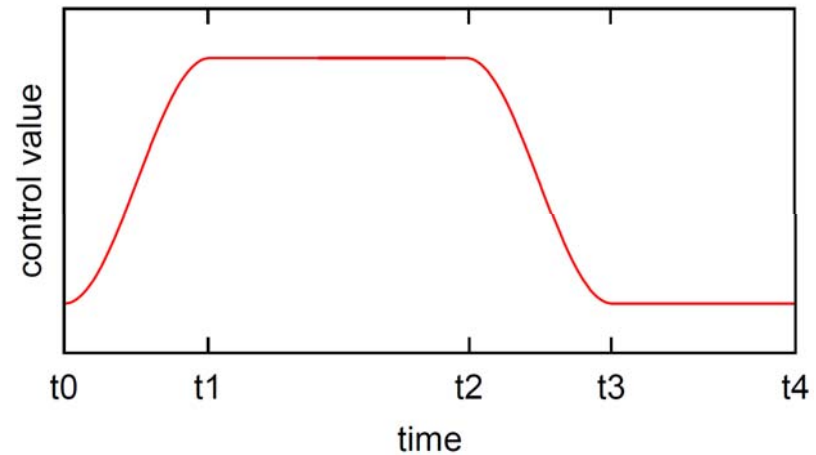
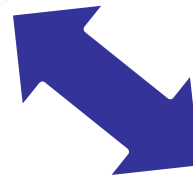

Quadratot: Genetic algorithm (GA)

Genome length	314 bits
Population size	200
Number of generations	300
Mutation rate	1/314
Crossover rate	0.2

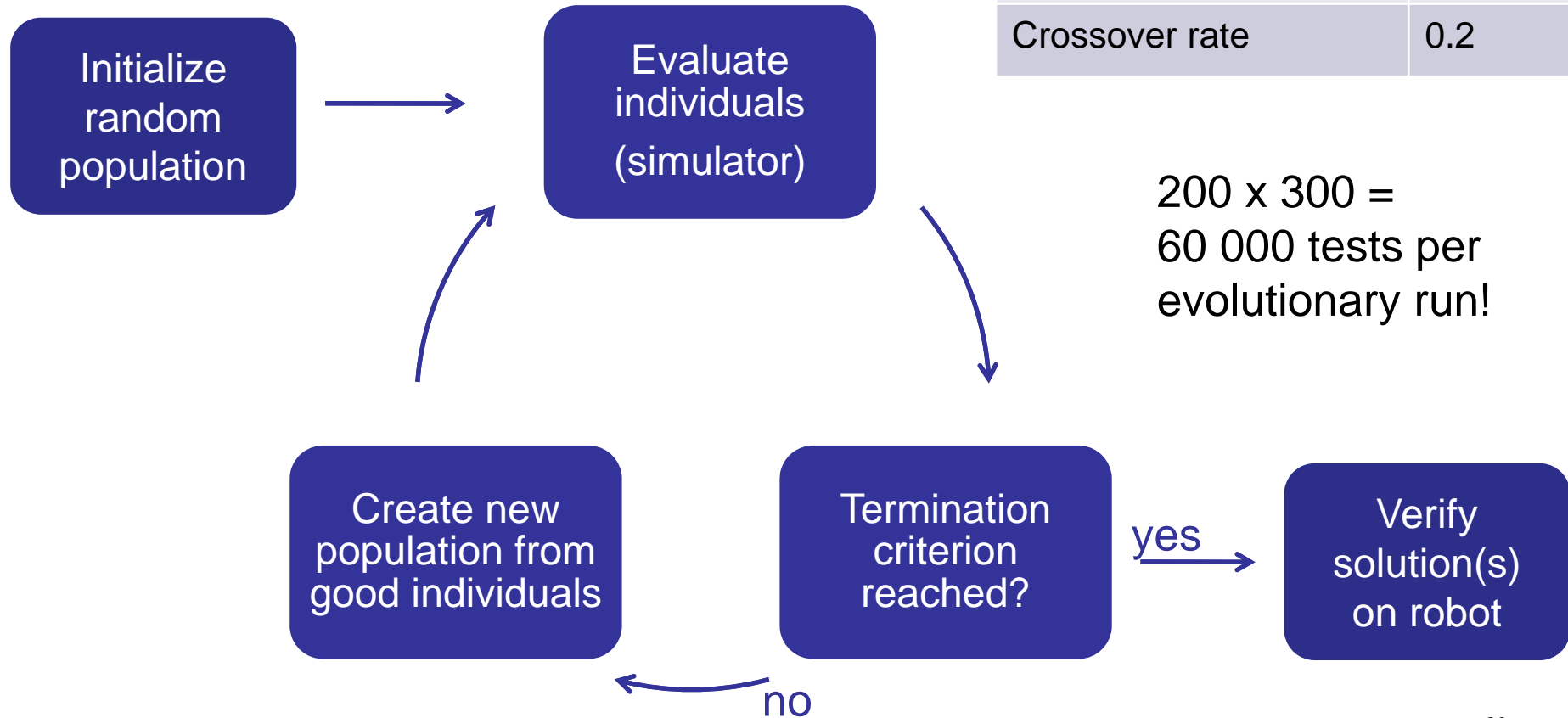



Motion capture

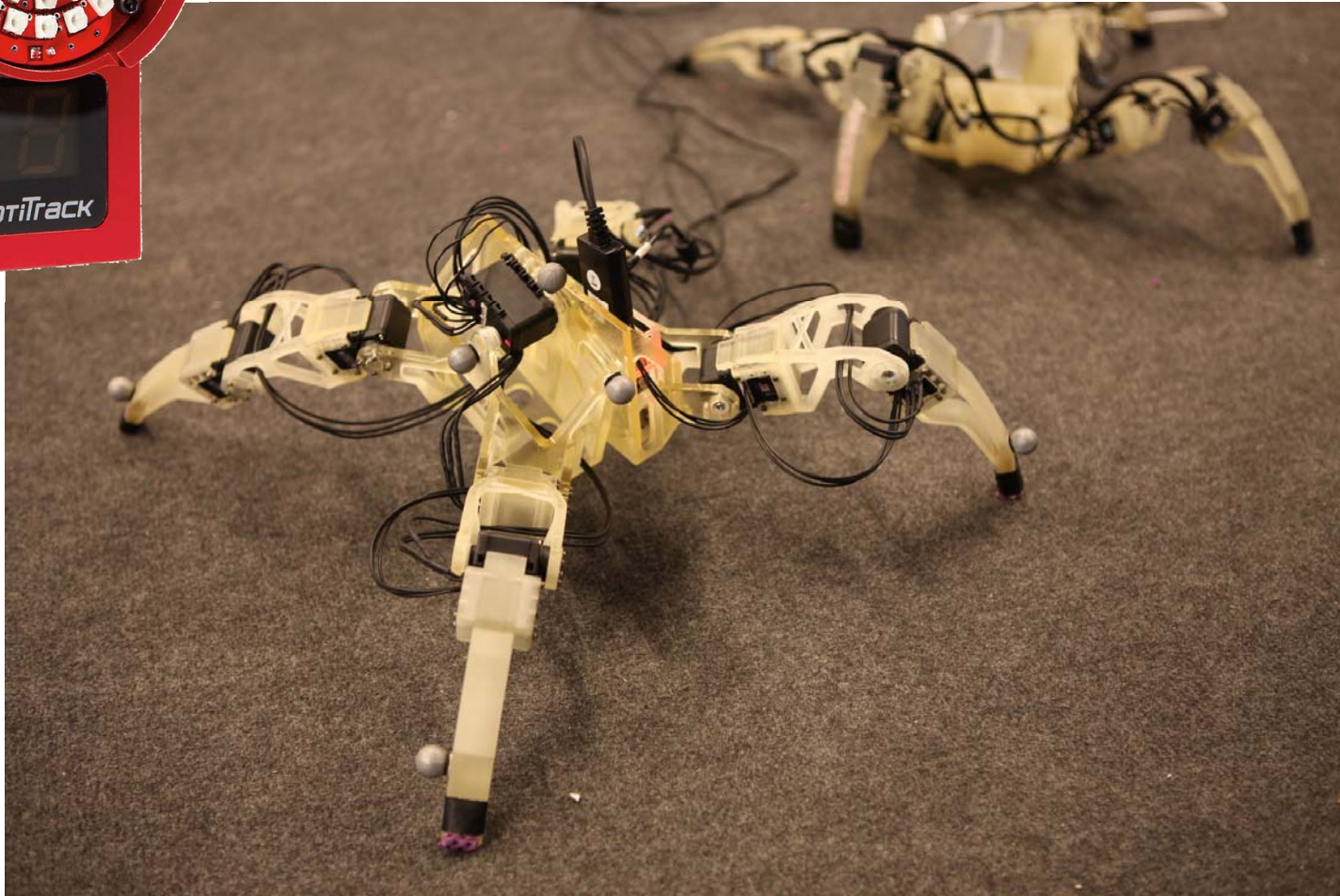

Quadratrot: Evolved gait

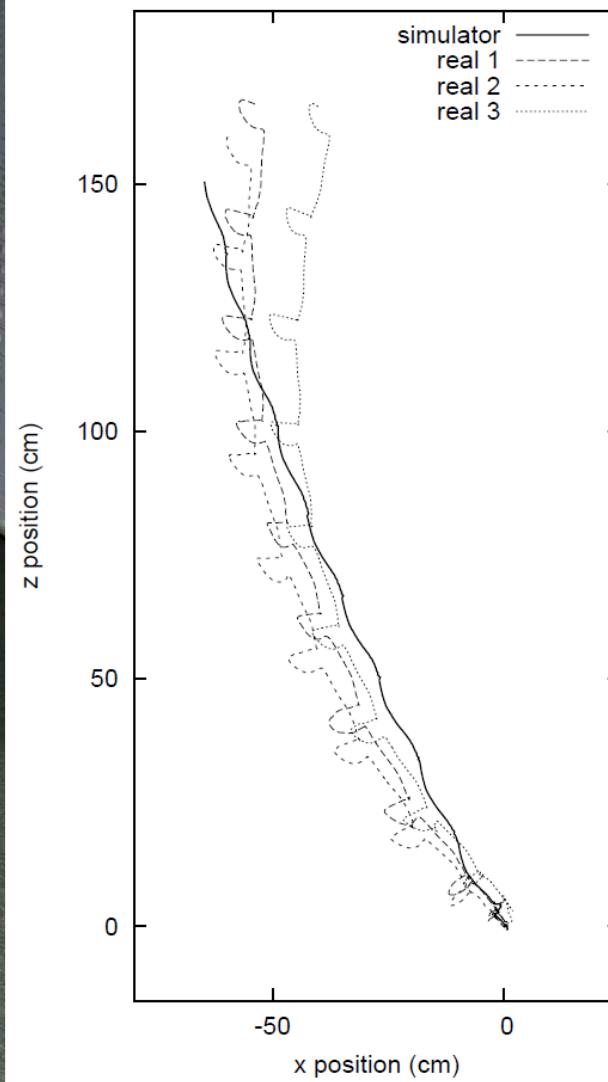
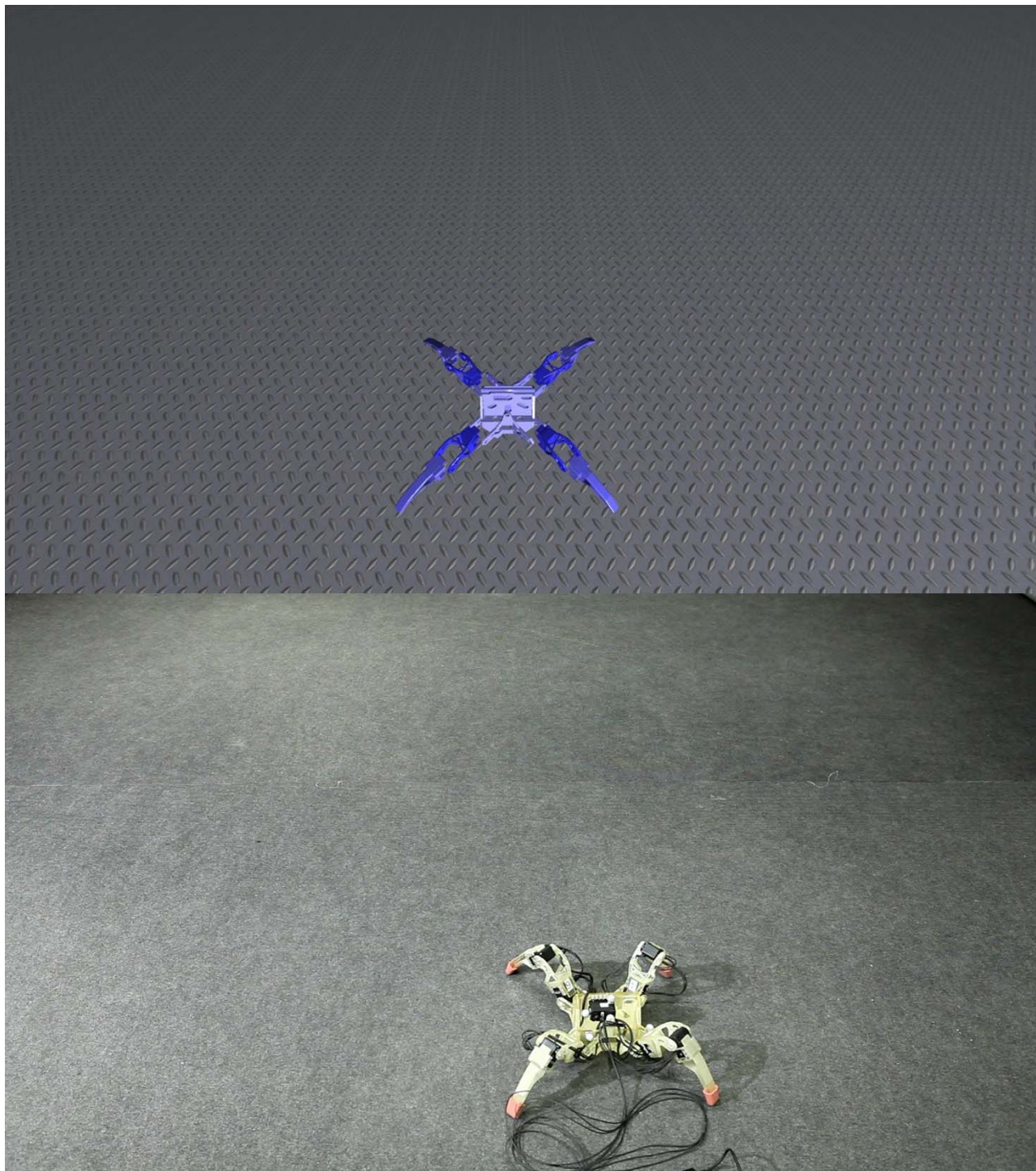

Benefits of simulation

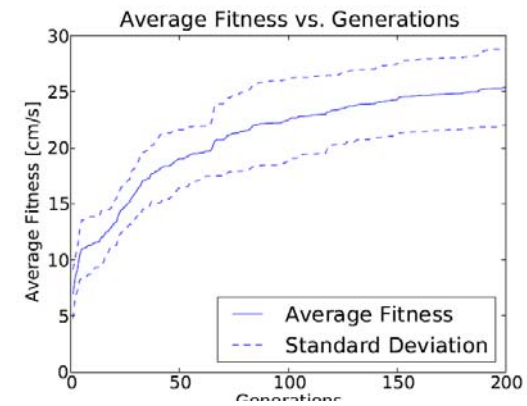
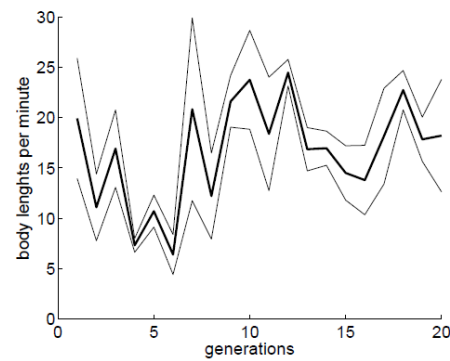
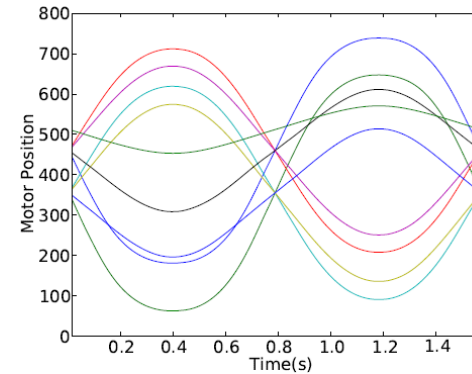
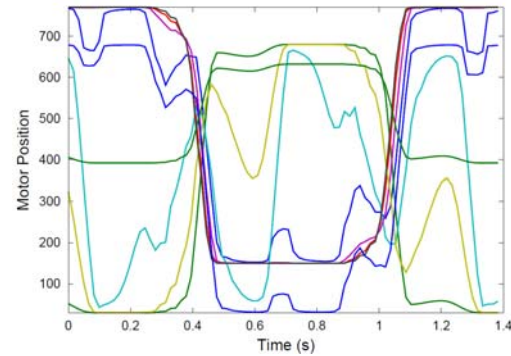

	Evaluations	Simulated Velocity	Real Vel. (CCML)	Real Vel. (ROBIN)
Parameterized gaits + optimization [25]	153	–	5.8	–
HyperNEAT in hardware [25]	180	–	9.7	–
RL PoWER Spline [18]	300	–	11.1	–
GA + simulator [9]	60000	*16.7	13.8	17.8
HyperNEAT + simulator [this paper]	40000	** 25.4	14.5	–

Challenge: Reality gap

- A simulator cannot capture all aspects of reality
- Evolved solutions may exploit features of the simulator not present in reality

→ The solutions evolved in simulation behave differently when applied to the real robot!

Quadratrot: Reality gap

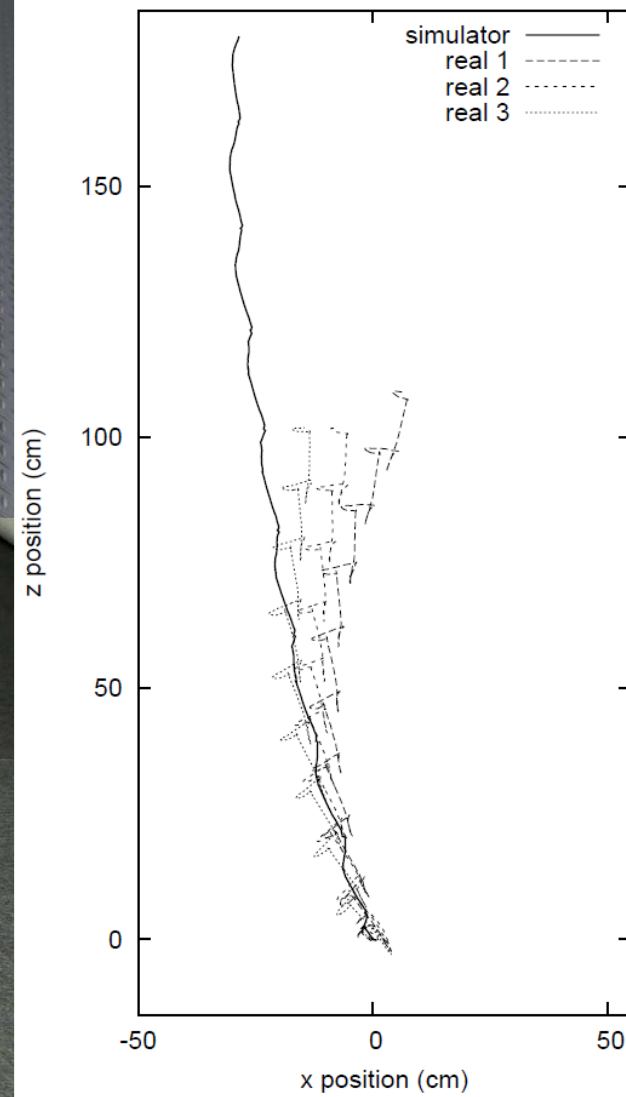
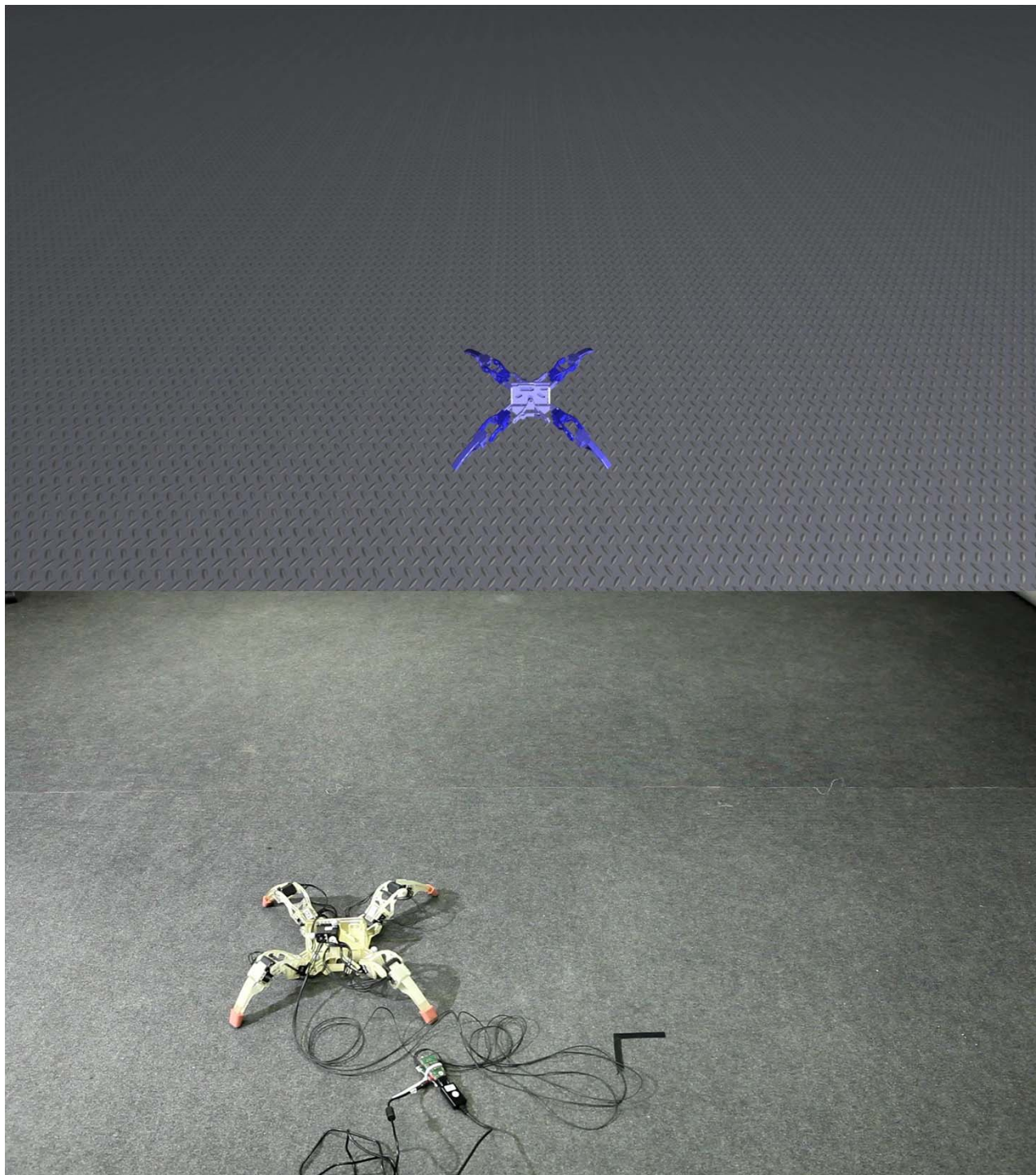

How to deal with the reality gap?

- Ideas?

How to deal with the reality gap

1. Increase simulation fidelity
 - Manually: do more precise measurements, increase solver accuracy
 - Automatically: measure deviation simulation-reality, auto-tune simulator for smaller deviation
2. Do not allow for solutions using badly simulated behaviour
 - Manually: E.g. Encourage slow, static movements, add noise
 - Automatically: Avoid solution types that transfer poorly
3. Online learning after deployment on real robot
 - Can use more evolution, reinforcement learning, or other method

1. Automatic simulator tuning

- Sample from real world
 - Test selected solutions on real robot
- Tune (evolve) simulator to fit all samples
- Evolve new solutions using tuned simulator

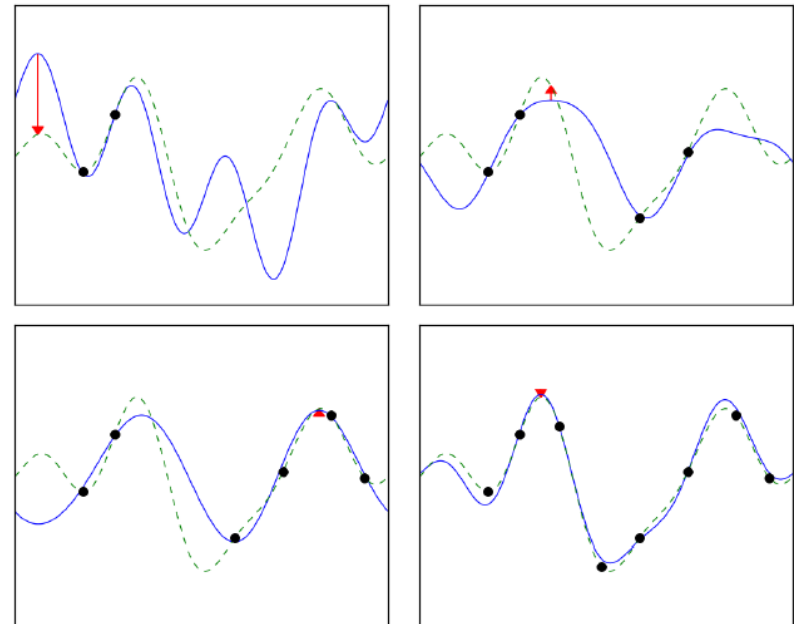

Self-modeling robot (Cornell U.)

- Creates self-model through exploratory actions
- Uses evolution to search for walking pattern using self-model
- If the robot is broken, a new self-model is constructed

<http://youtu.be/3HFAB7frZWM>

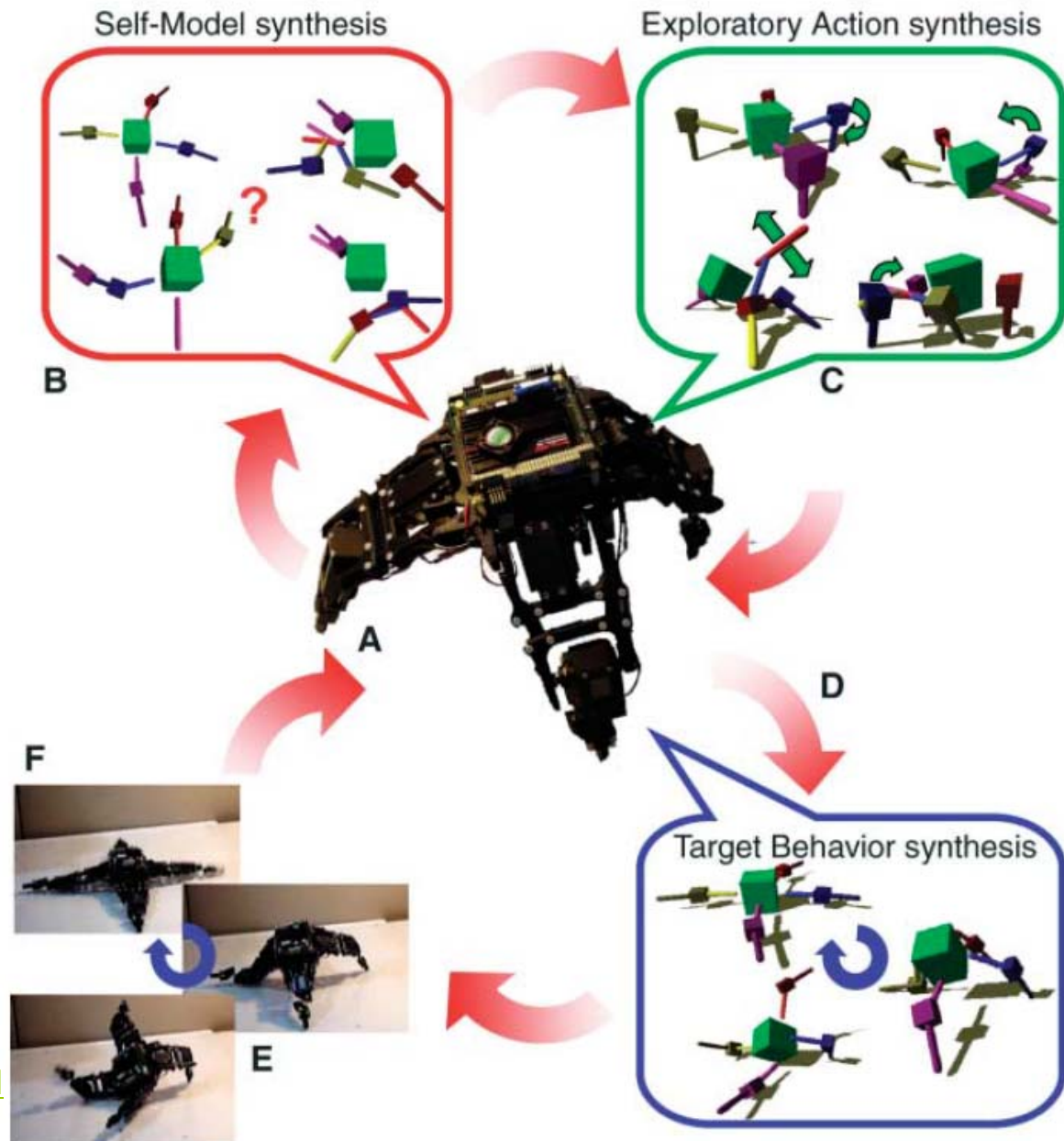

2. Transferability (UPMC, Paris)

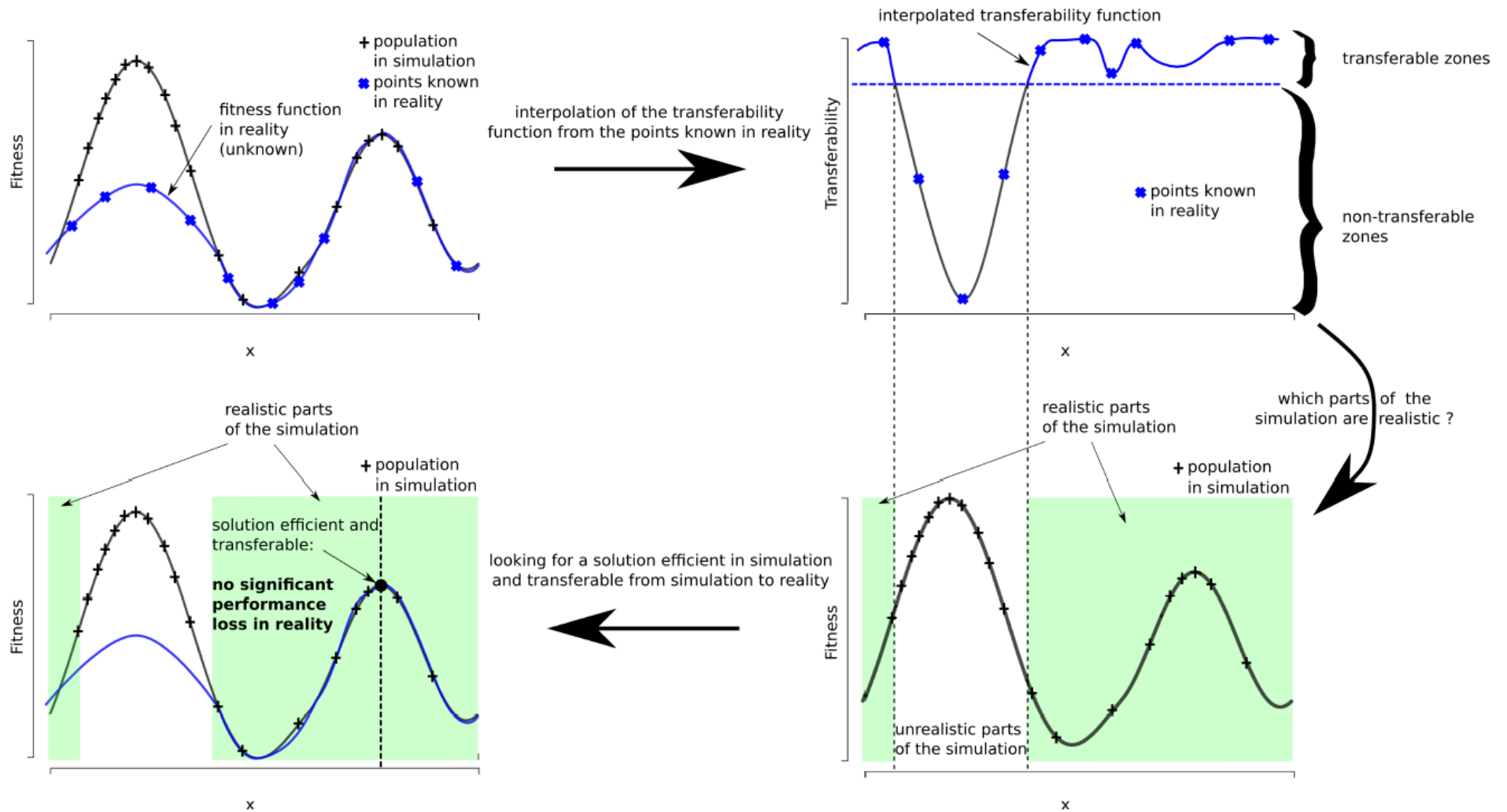

3. Adaptation after transferral (VIDEO)

- Reality gap is «accepted»
- Adaptation algorithm is carried out on the real robot
- Needs to take into account fewer tests and more noise

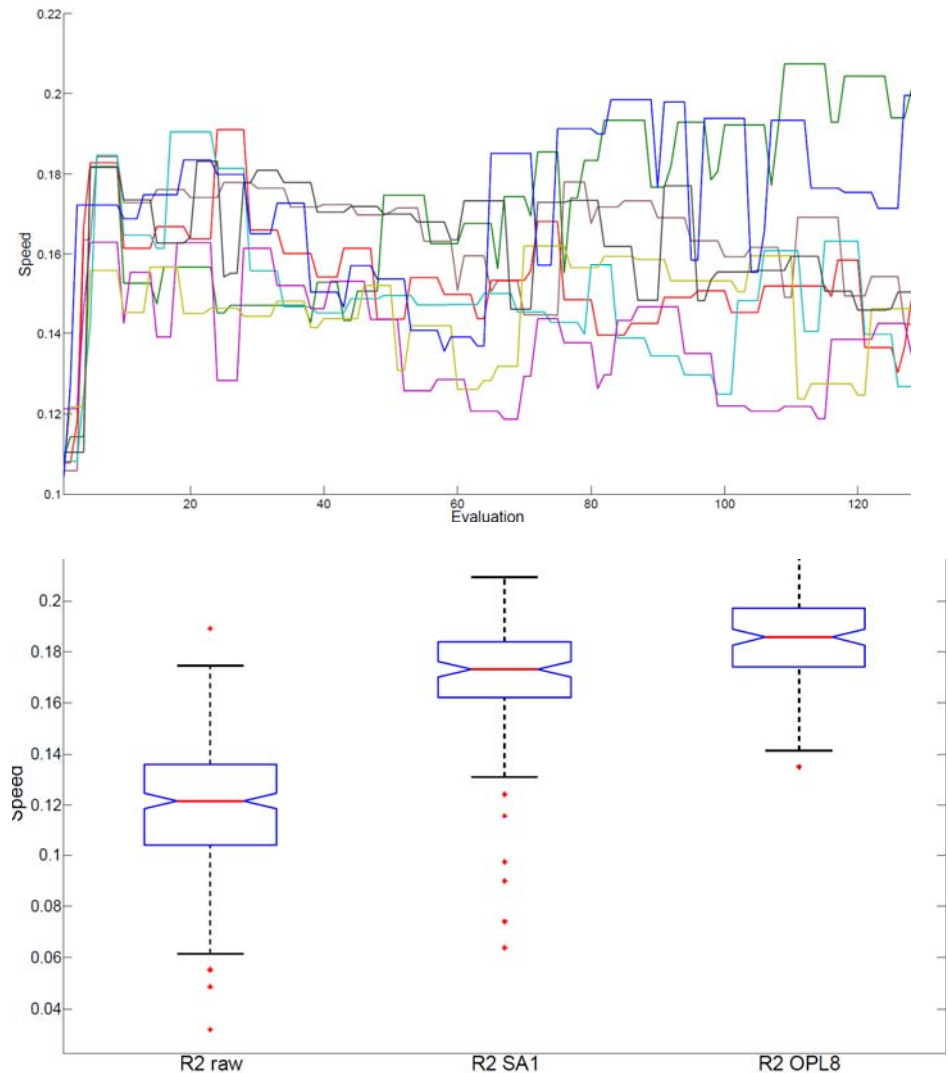

Evolving shape and control

- Physics simulation allows evolution of shape and control simultaneously
 - More efficient designs for complex problems?
 - New designs for new environments?
 - Allows for offloading computation to the body?
- Sims: http://youtu.be/JBgG_VSP7f8
- GOLEM: http://youtu.be/sLtXXFw_q8c
- Soft robot: <http://youtu.be/z9ptOeByLA4>

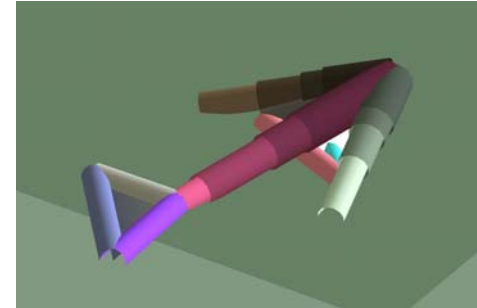
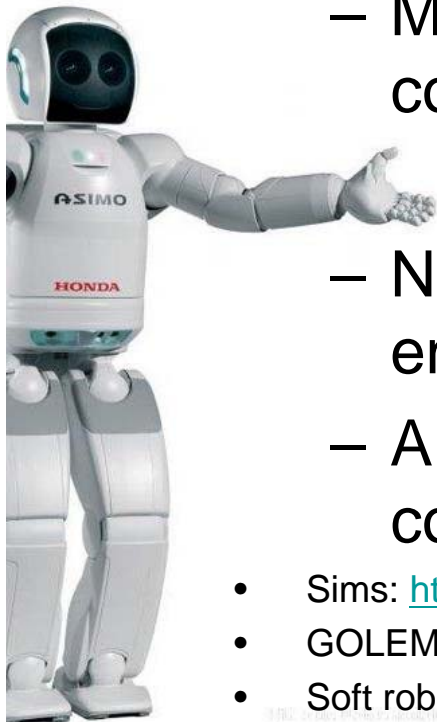

Example: «hox» body evolution

- Generative approach
 - A program builds the robot plan rather than all parameters directly coded
 - Allows a variety of bodies from a compact code
- Designed for production with 3D printer and commercial servos

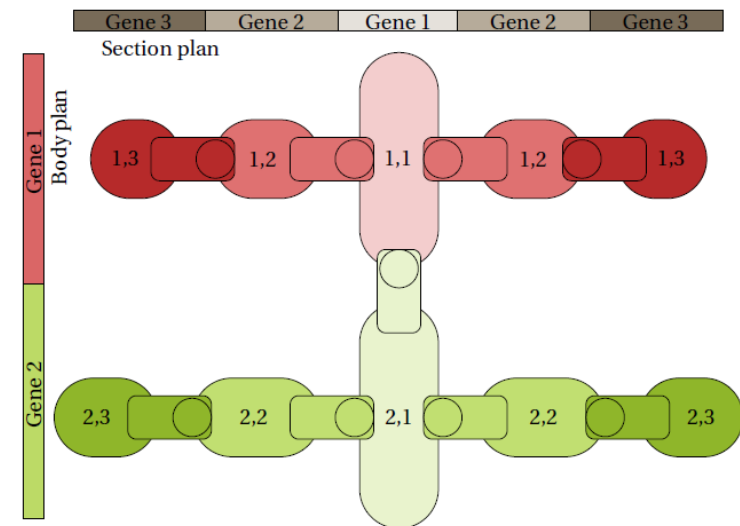

«hox»: Some results (video)

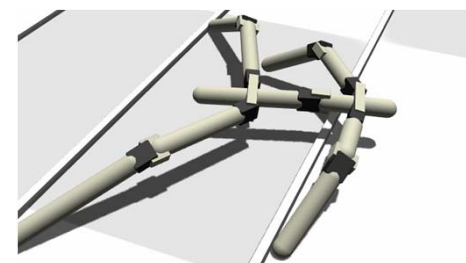
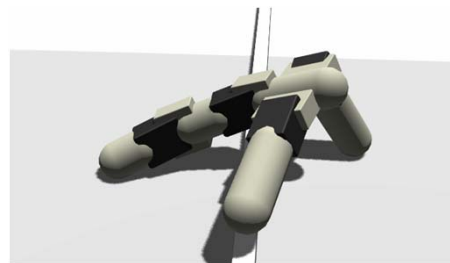
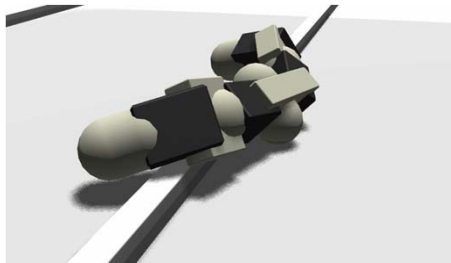

Results: different bodies

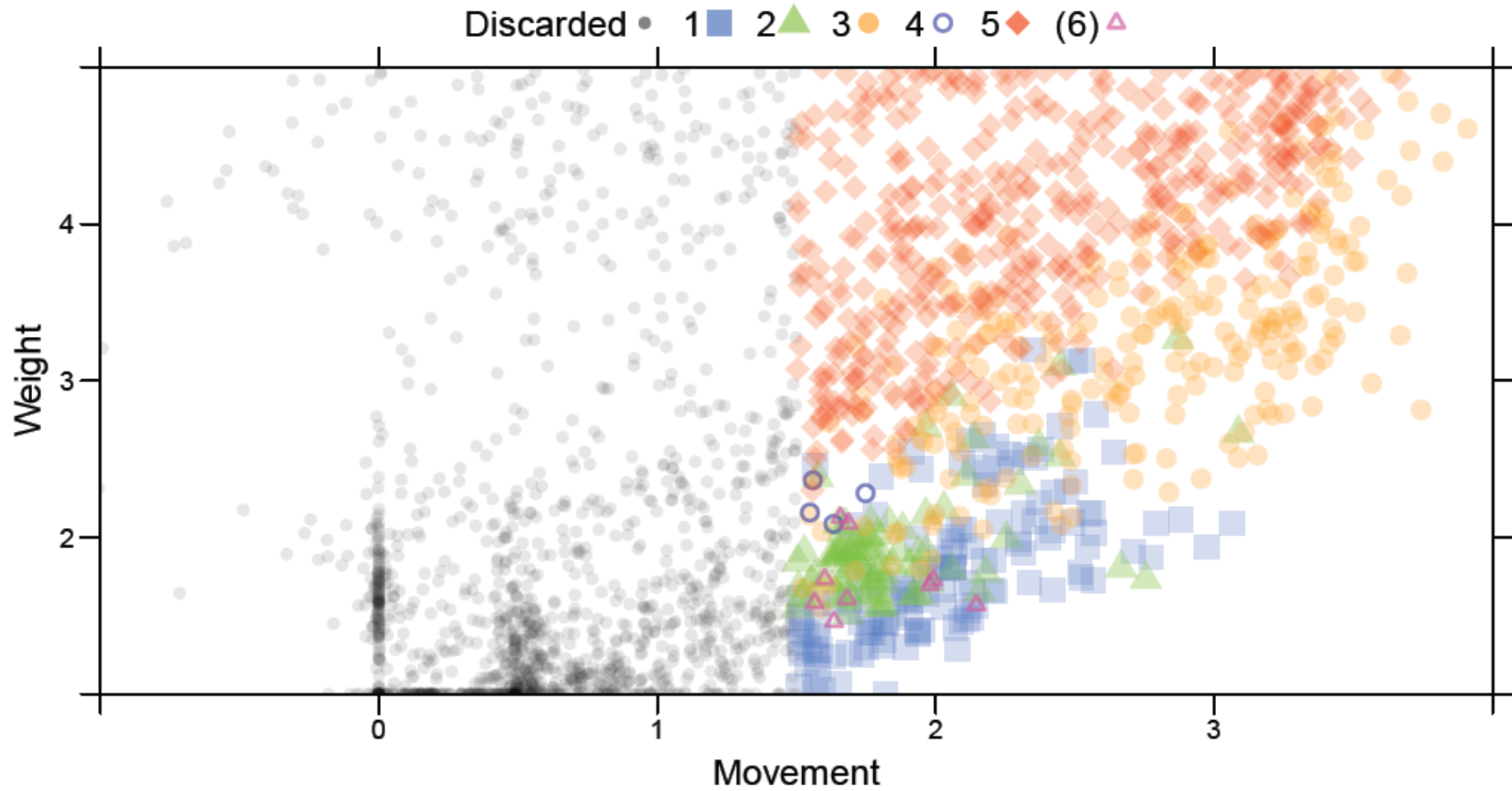

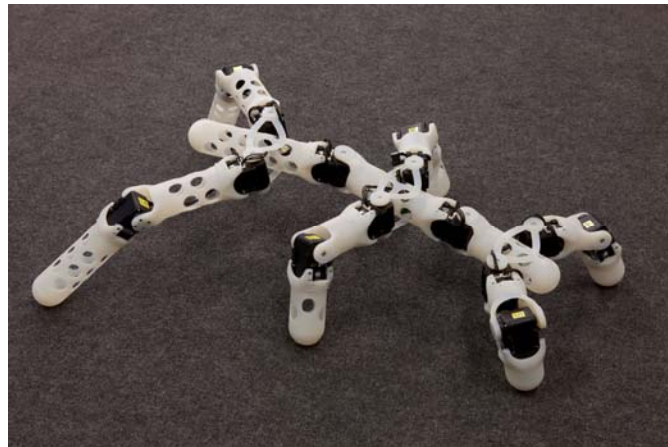

Example: Karkinos (MSc. project)

- Hybrid automatic / engineered design of robot shape and control

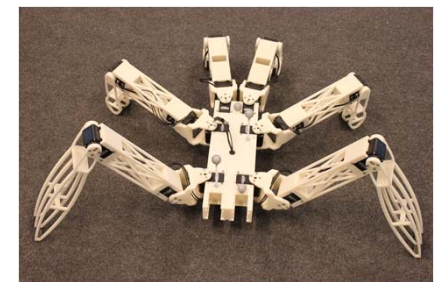
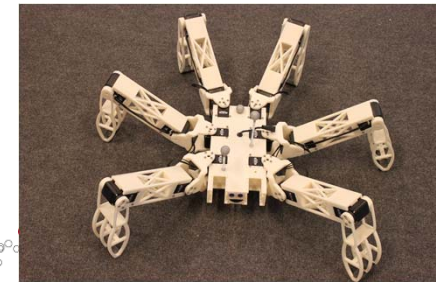
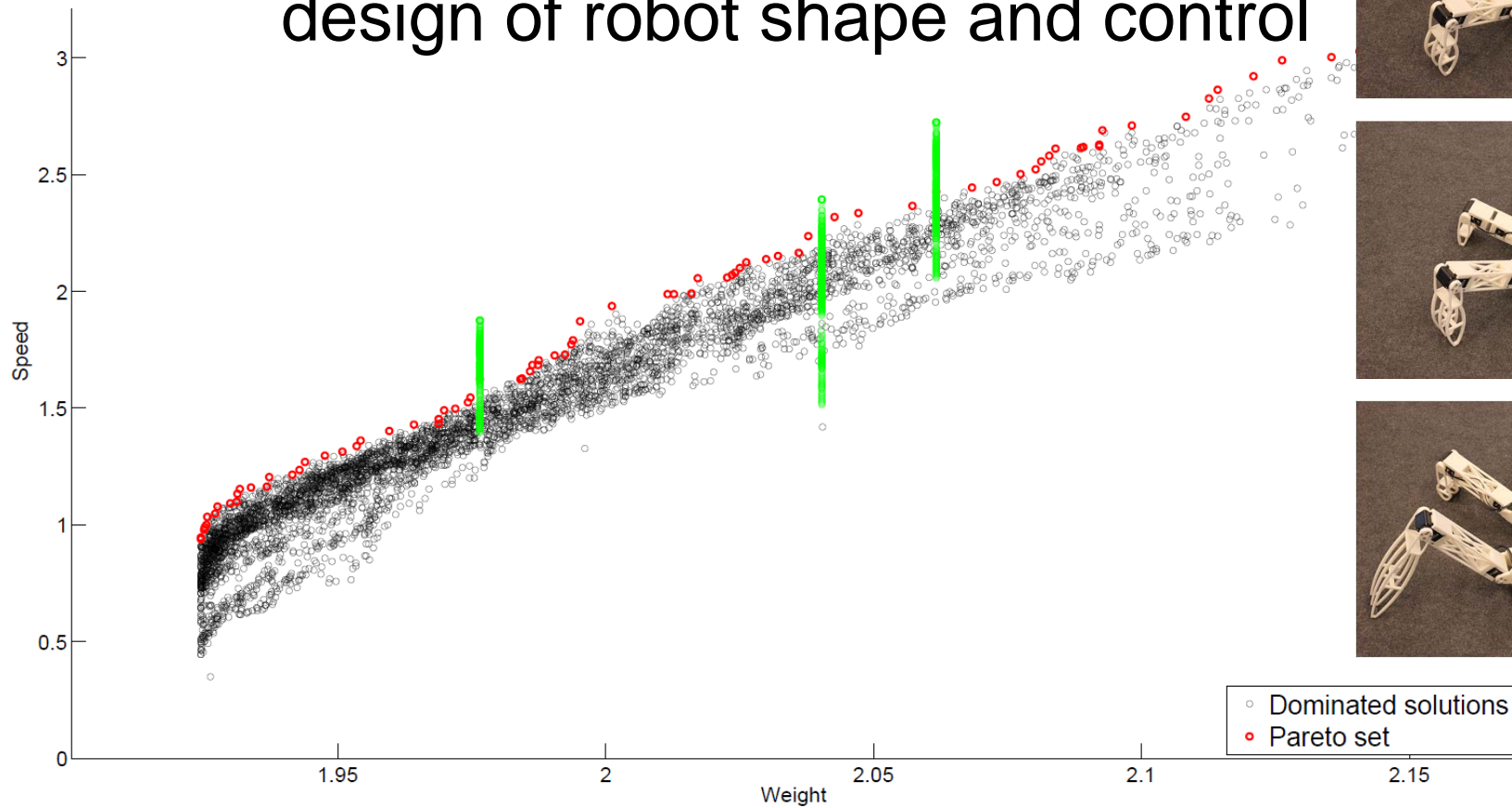

Master's projects in evolutionary robotics at the ROBIN group

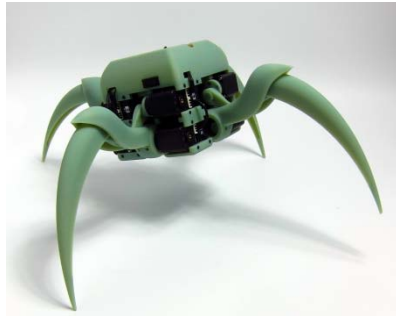

- Integration of locomotion learning platform
(evolutionary algorithm + simulator + hardware interface + motion capture)
- Evolution of locomotion patterns for robots
(walking, crawling, obstacles, robustness, neural networks, comparing with other learning methods)
- Reality gap research
(testing various algorithms for a smooth transfer from simulator to reality)
- Design and build new robot
(CAD, 3D print, electronics, simulator)



<http://www.mn.uio.no/ifi/studier/masteroppgaver/robin/>

Relevant courses

- INF3490 Biologically inspired computing
- [INF4500 Rapid prototyping of robotic systems](#)

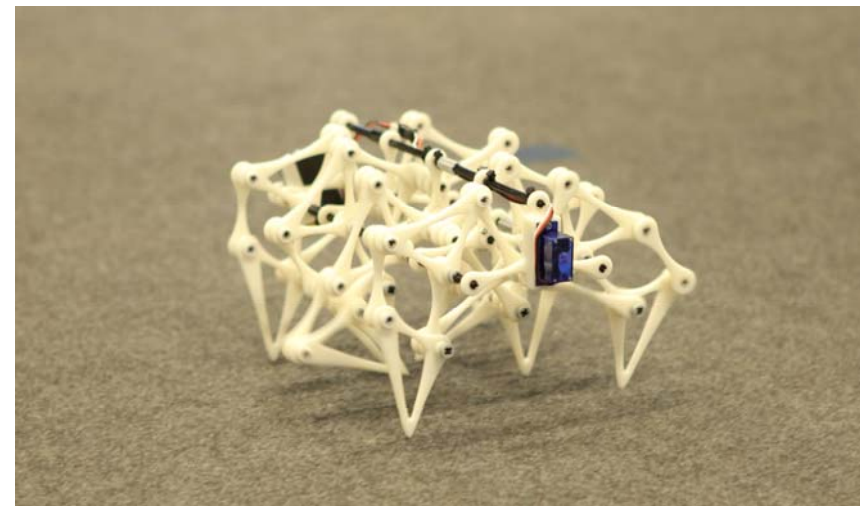
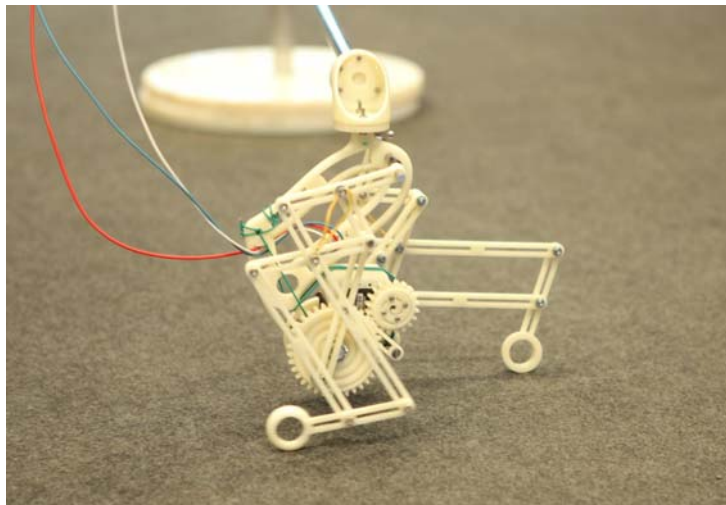

Summary

- Evolutionary robotics can be useful for adaptation, optimization, design exploration
- Simulation is useful for evolutionary search
- The reality gap remains a research challenge
 - Simulator tuning, transferability, online adaptation
- Co-evolution of body and control gives new possibilities