

7.2

a.

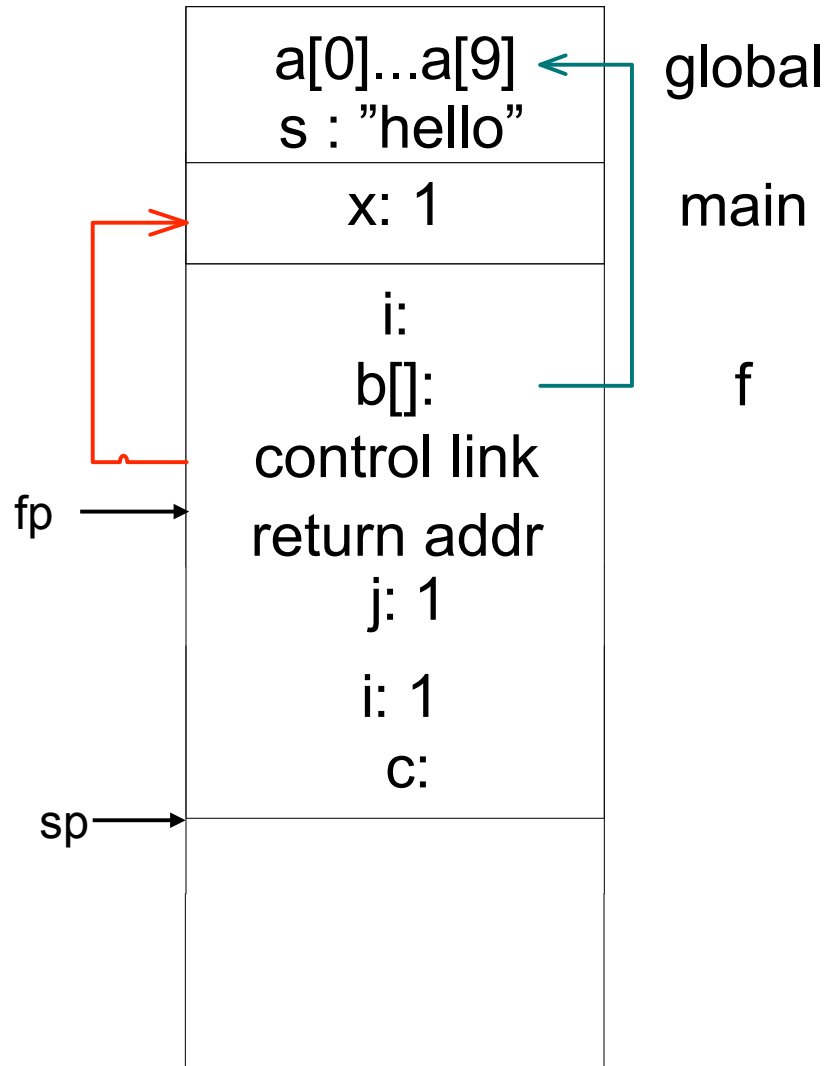

b.

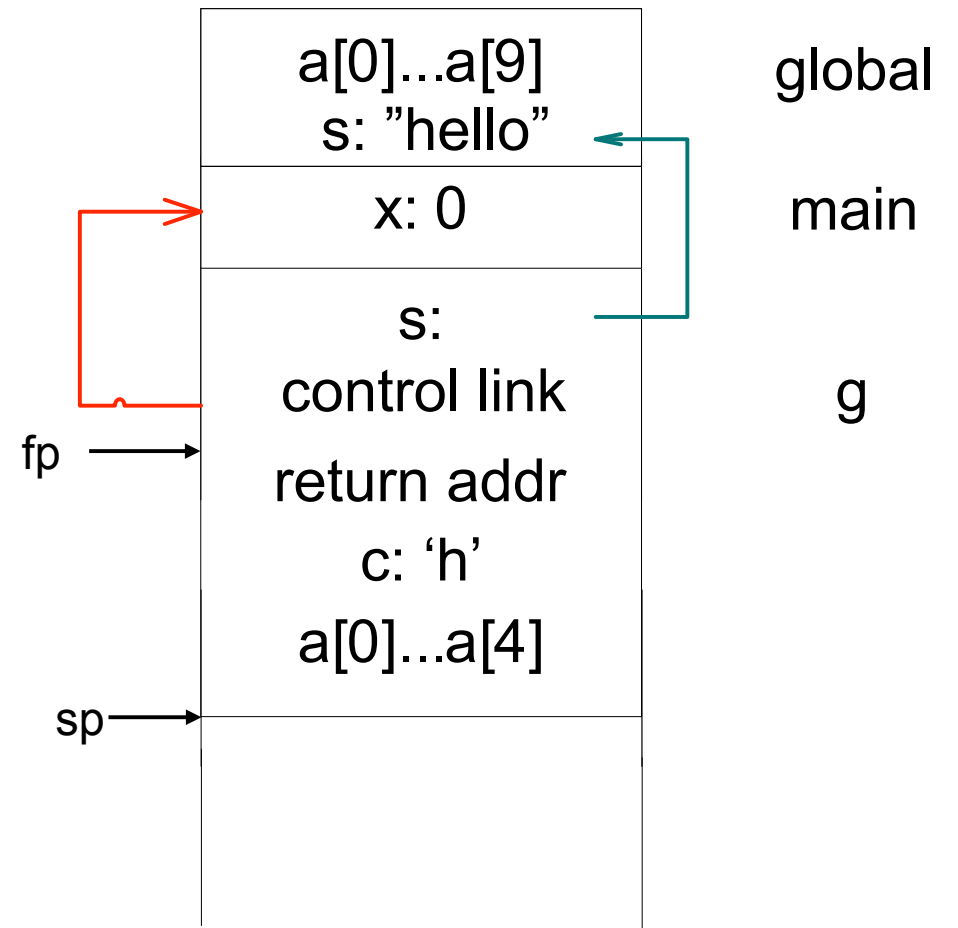

7.4

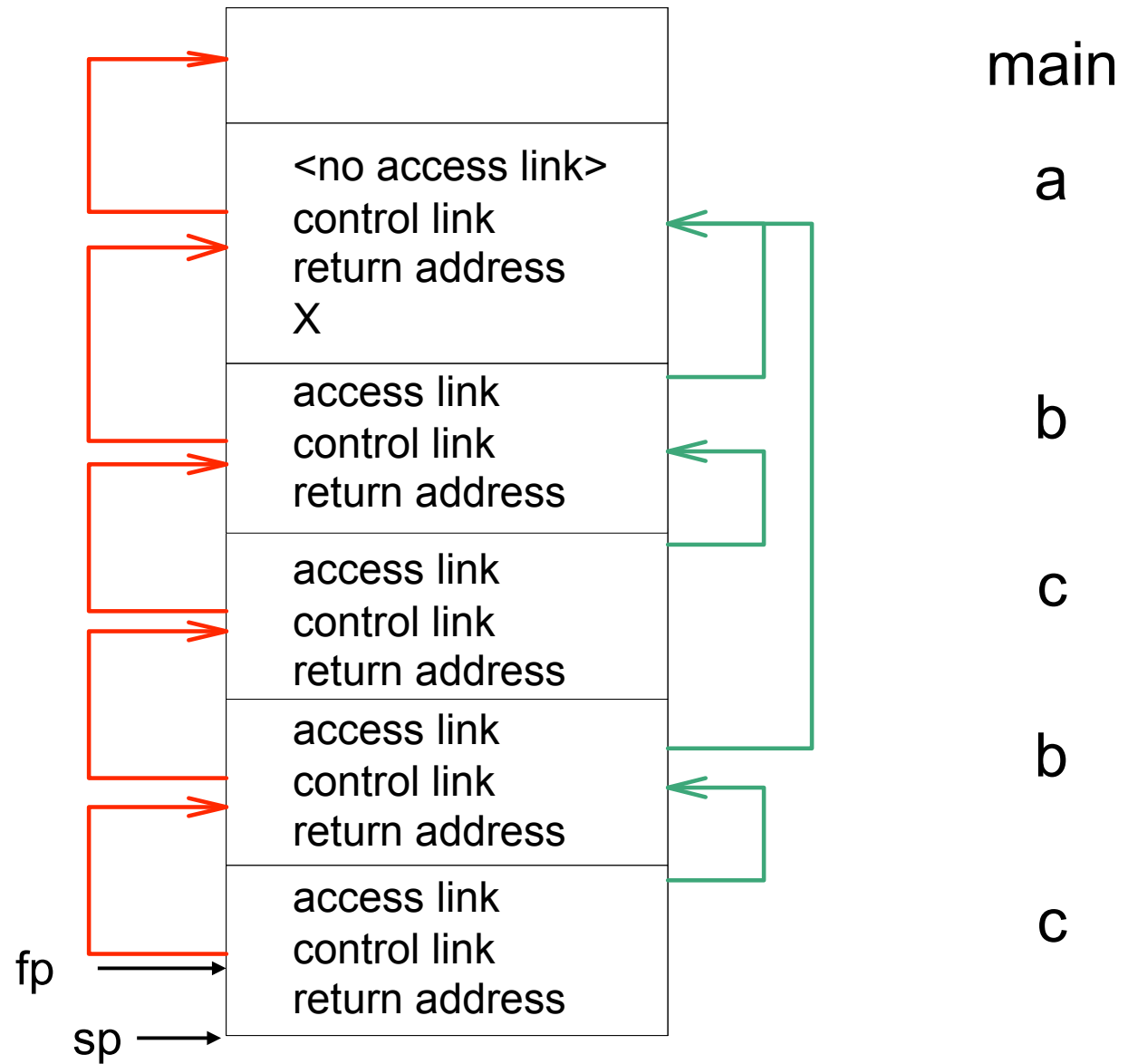

7.10

- a) I stedet for å følge aksess link trenger man bare å slå opp i Display for å finne den aktuelle aktiveringsblokken

b)

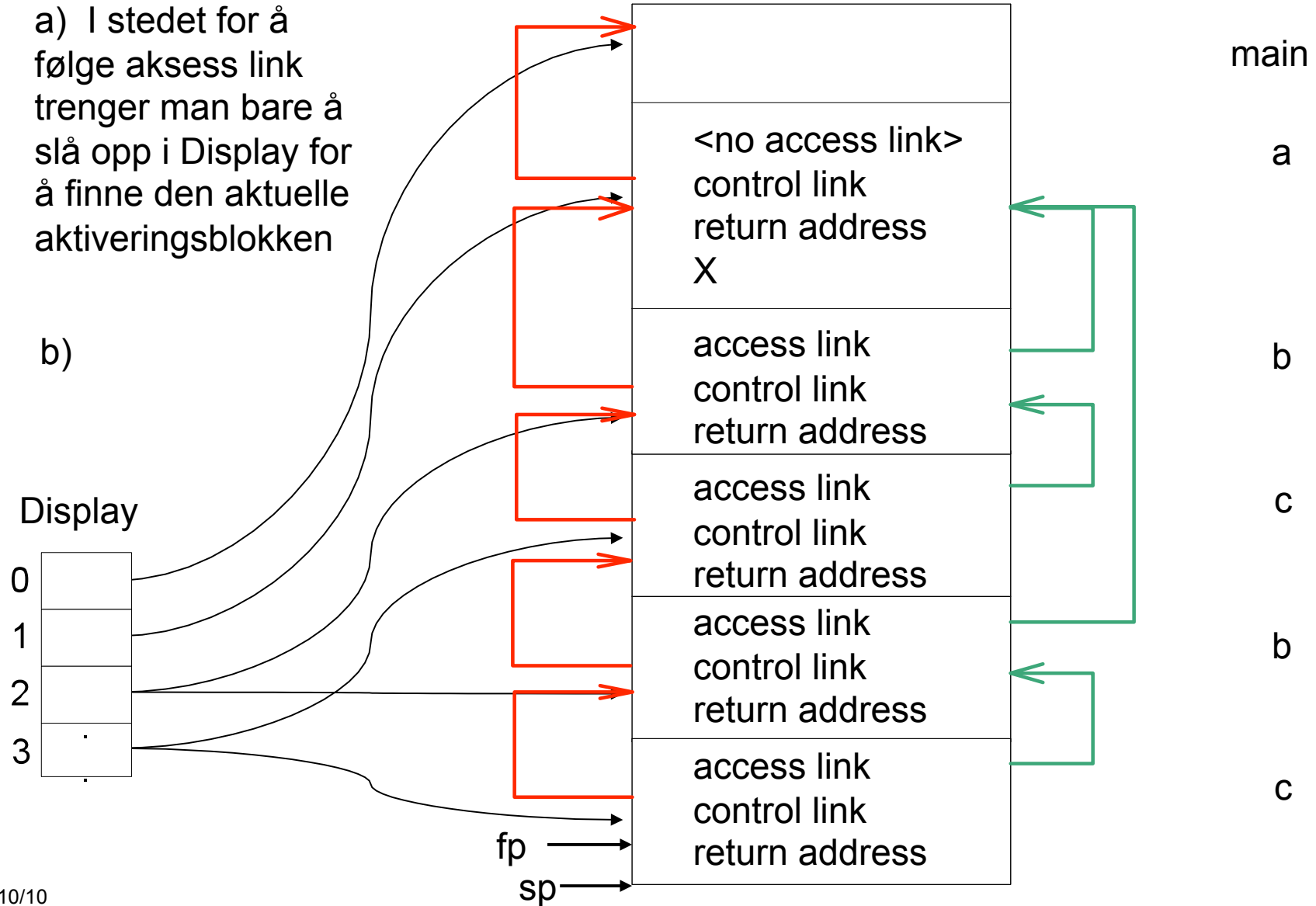

7.13 Draw the memory layout of objects of the following C++ classes, together with the virtual function tables as described in Section 7.4.2:

```

class A
{ public:
  int a;
  virtual void f();
  virtual void g();
};

class B : public A
{ public:
  int b;
  virtual void f();
  void h();
};

class C : public B
{ public:
  int c;
  virtual void g();
}

```

A-objekt

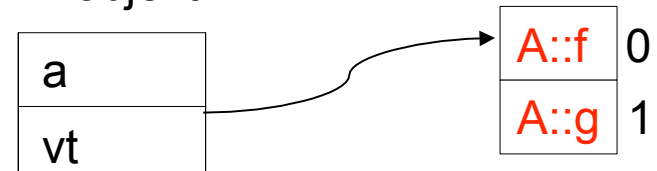

B-objekt

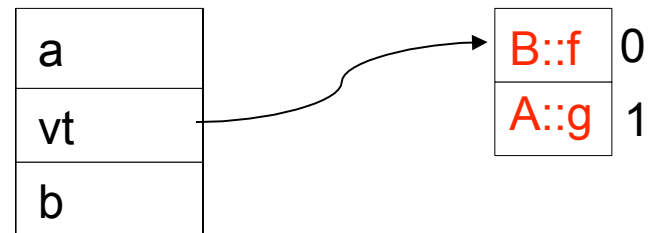

C-objekt

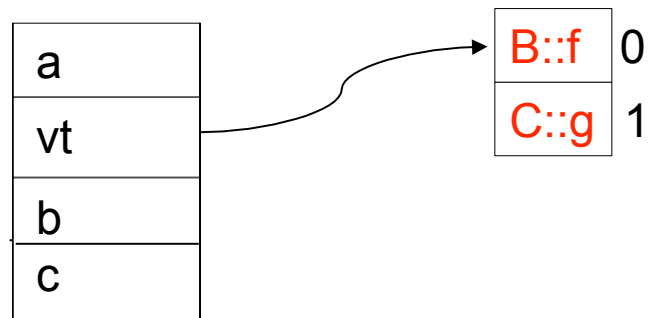

7.15 Give the output of the following program (written in C syntax) using the four parameter passing methods discussed in Section 7.5:

```

#include <stdio.h>
int i=0;

void p(int x, int y)
{ x += 1;
  i += 1;
  y += 1;
}

main()
{ int a[2]={1,1};
  p(a[i],a[i]);
  printf("%d %d\n",a[0],a[1]);
  return 0;
}

```

by value	by reference
1 1	3 1
by value-result	by name
2 1 1 2	2 2

7.15 by reference

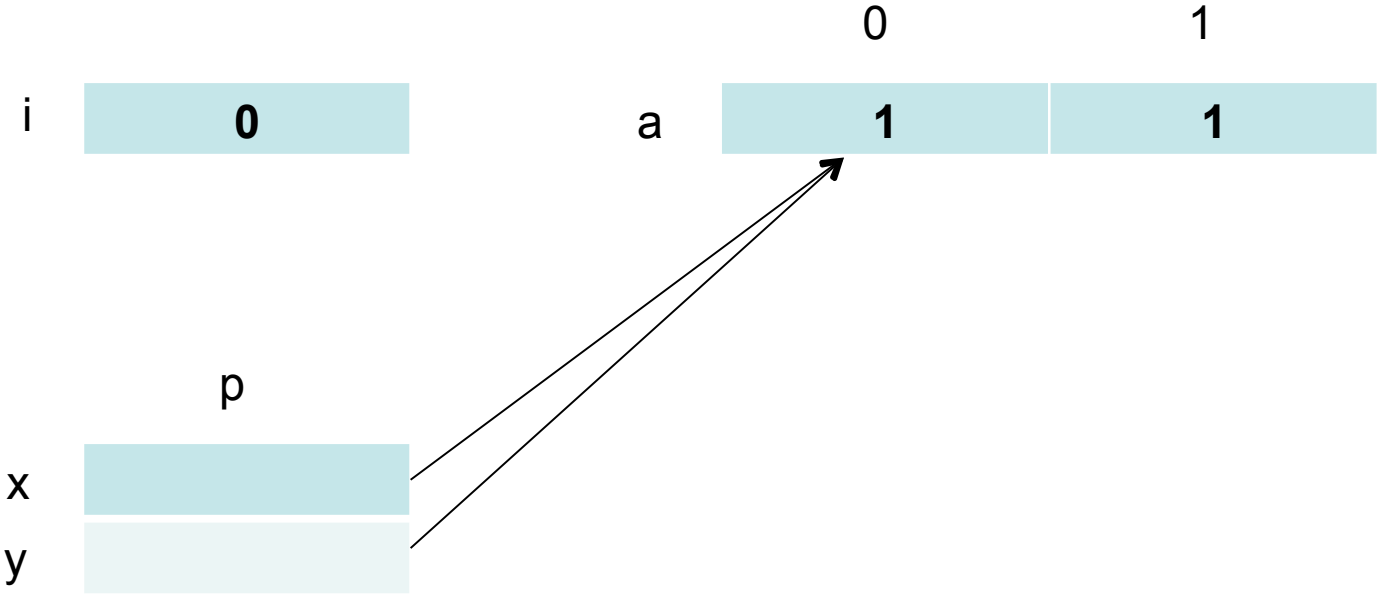

7.15 by value-result – address at call

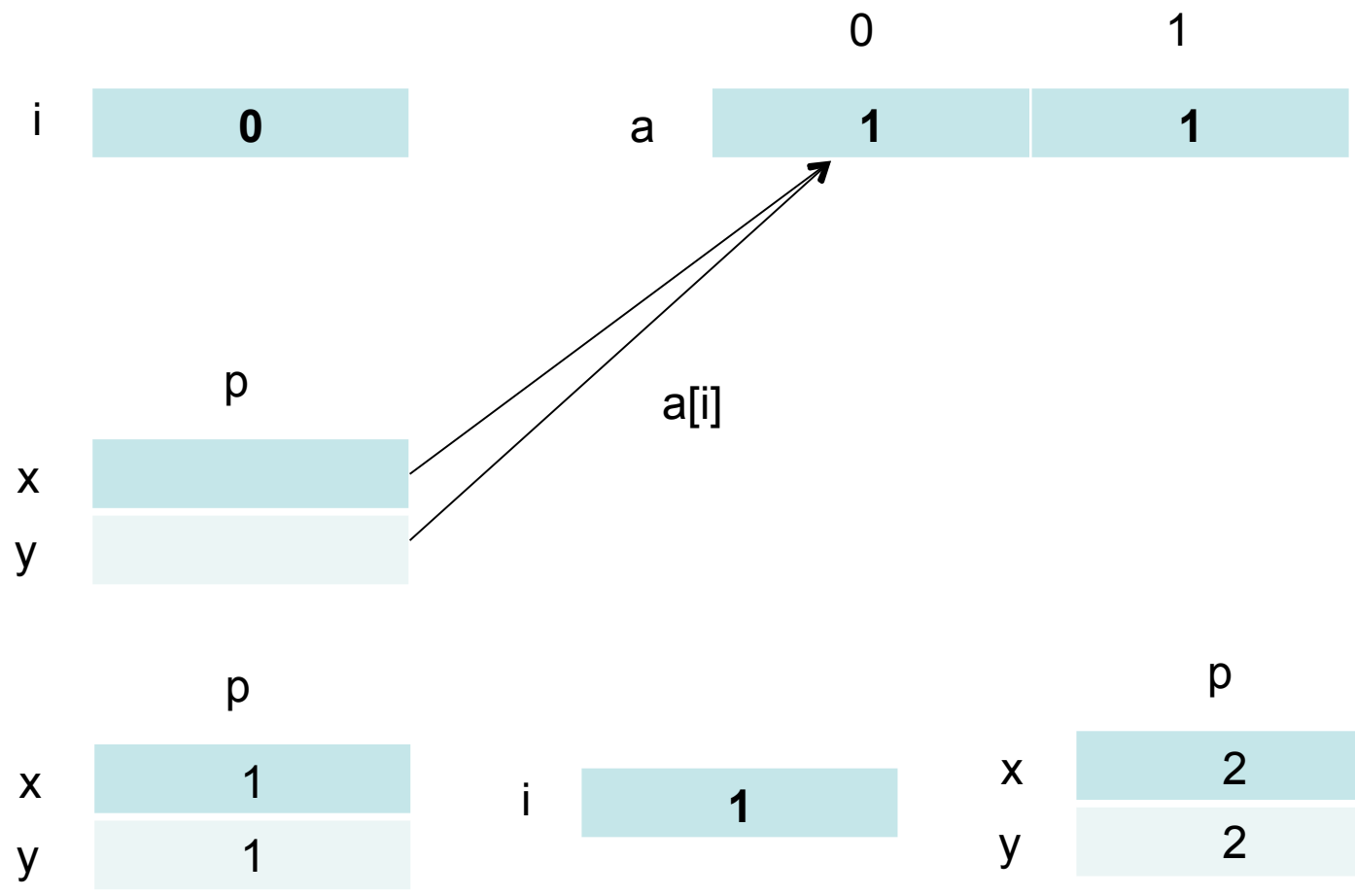

7.15 by value-result – address at exit

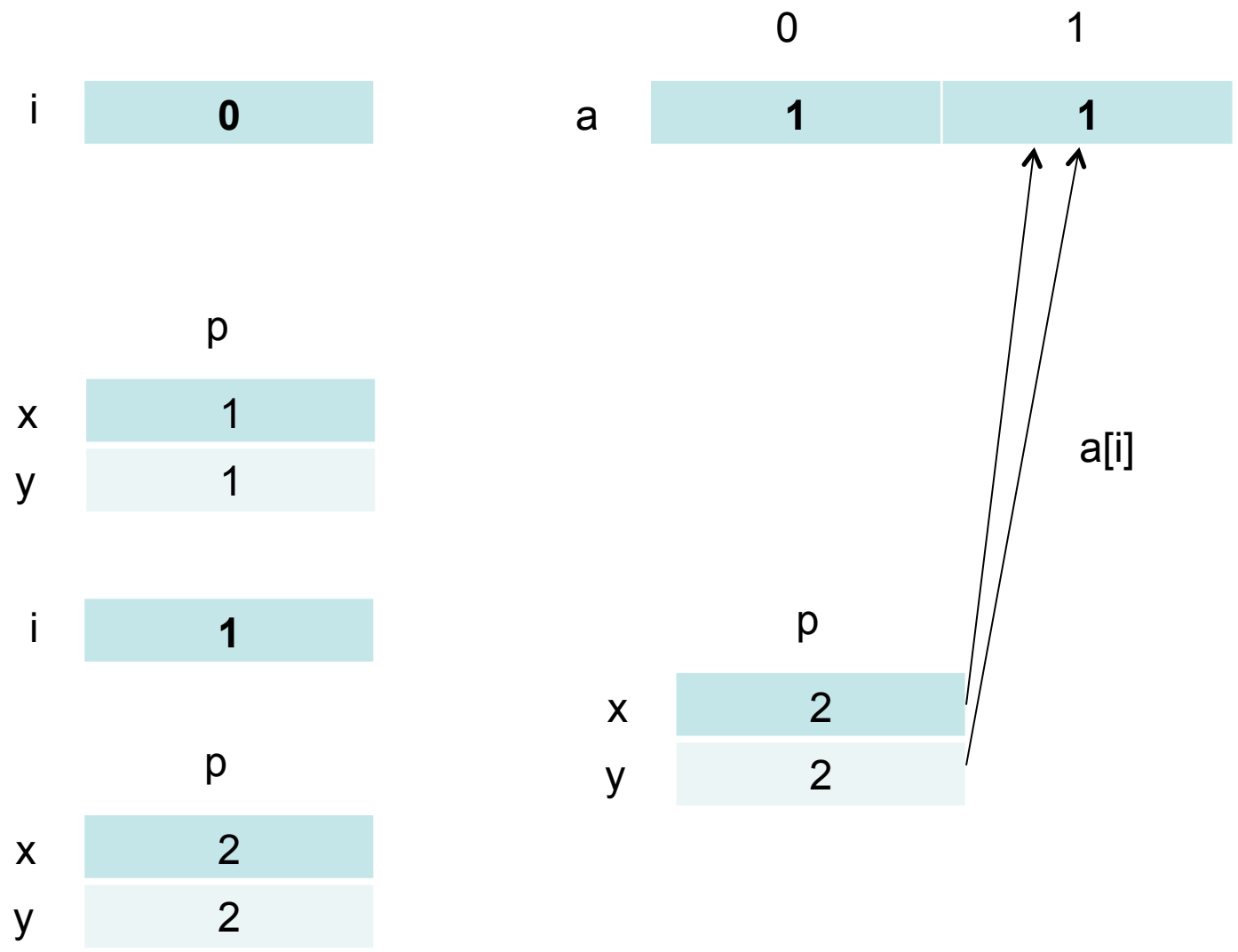

7.15 by name

$$a(i) = a(i) + 1 \quad == \quad a(0) = a(0) + 1 = 1 + 1 = 2$$

$$i = i + 1 \quad == \quad i = 0 + 1 = 1$$

$$a(i) = a(i) + 1 \quad == \quad a(1) = a(1) + 1 = 1 + 1 = 2$$

7.16

Give the output of the following program (in C syntax) using the four parameter passing methods of Section 7.5:

```
#include <stdio.h>
int i=0;

void swap(int x, int y)
{ x = x + y;
  y = x - y;
  x = x - y;
}

main()
{ int a[3] = {1,2,0};
  swap(i,a[i]);
  printf("%d %d %d %d\n",i,a[0],a[1],a[2]);
  return 0;
}
```

by value	by reference
0 1 2 0	1 0 2 0
by value-result	by name
1 0 2 0 1 1 0 0	2 1 -1 0

7.16 by reference

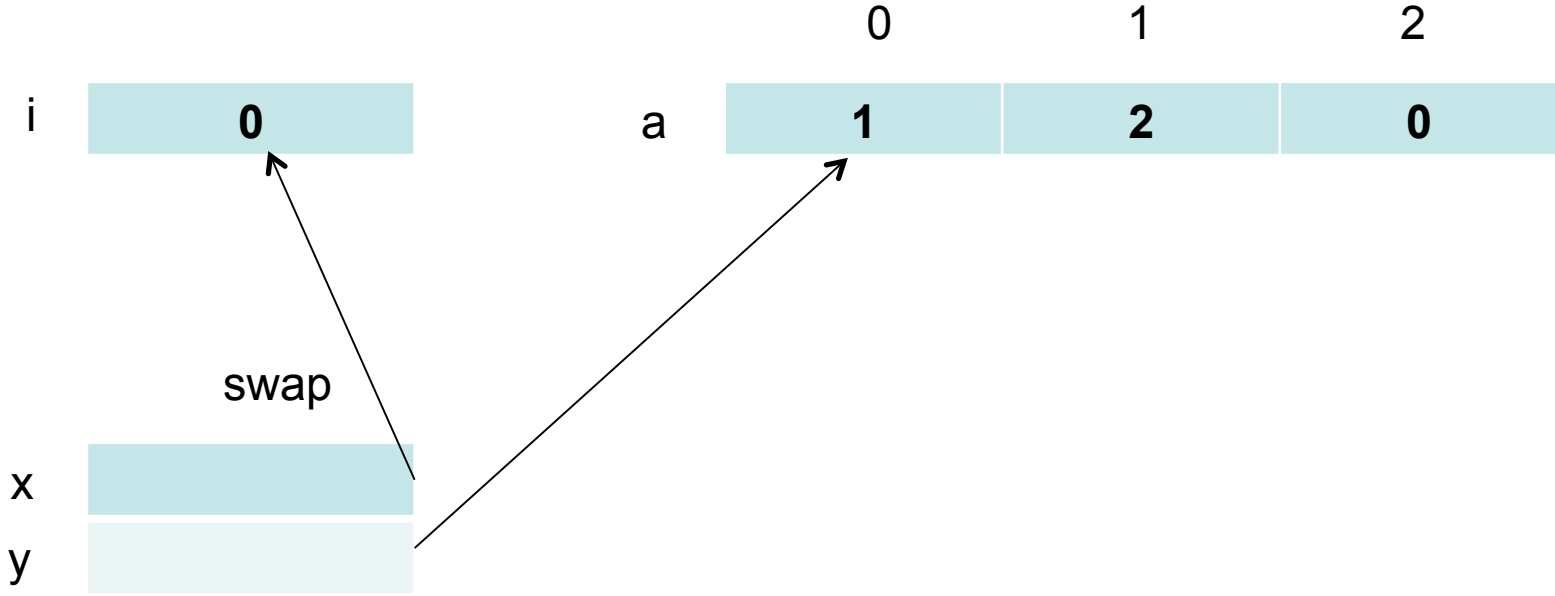

7.16 by value-result – address at call

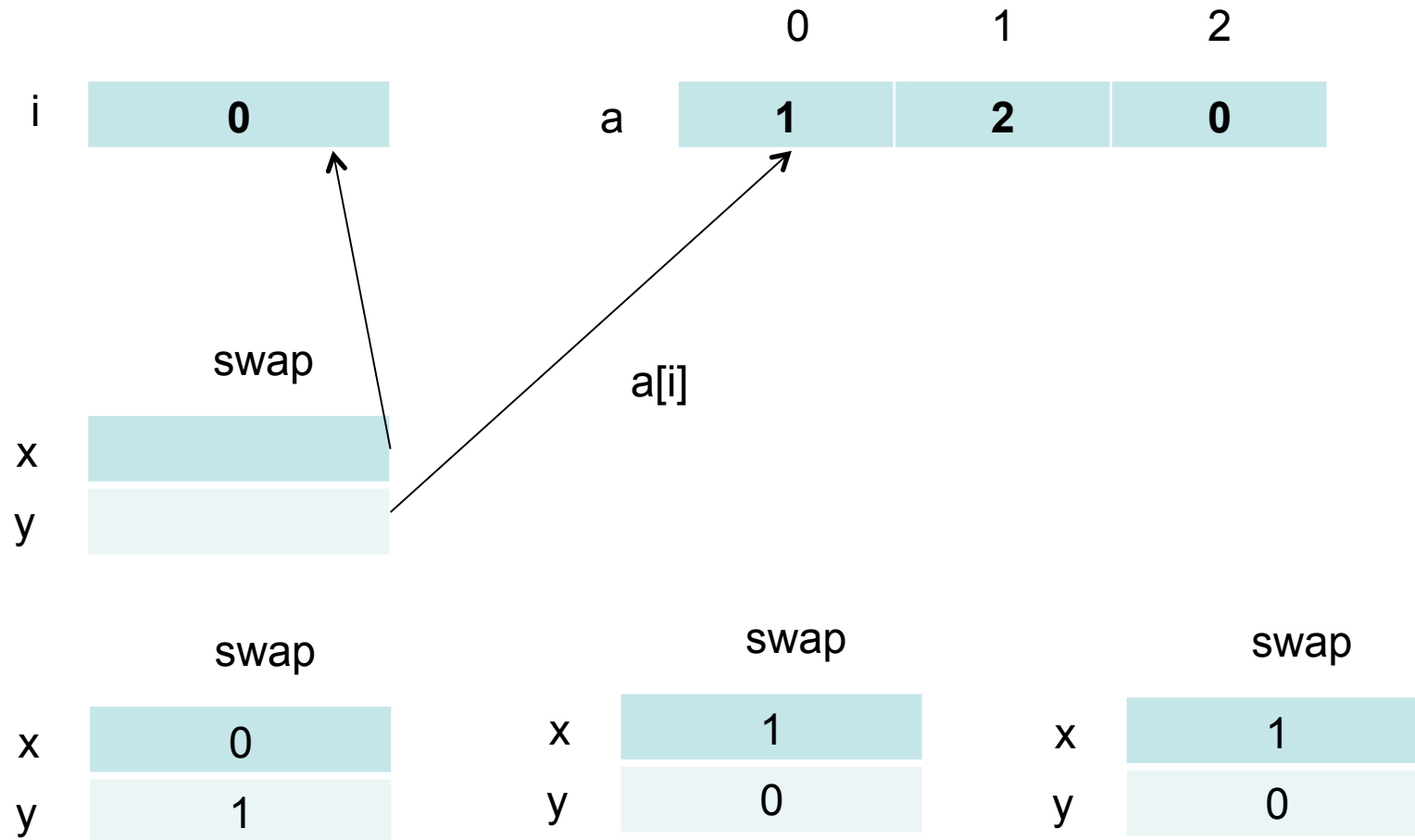

7.16 by value-result – address at exit

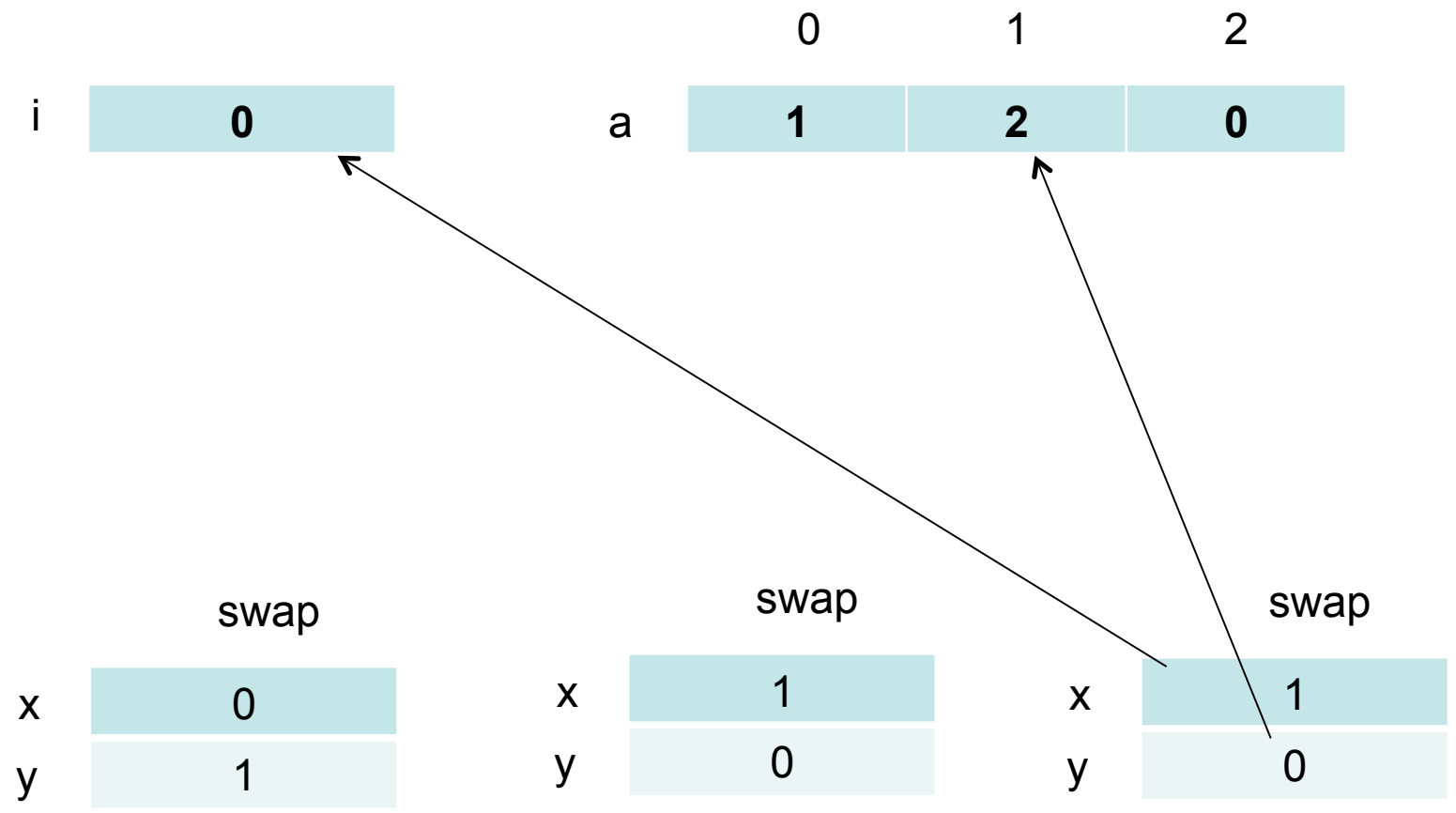

7.16 by name

$$i = i + a(i) \quad == \quad i = 0 + 1 = 1$$

$$a(i) = i - a(i) \quad == \quad a(1) = 1 - a(1) \quad == \quad a(1) = 1 - 2 = -1$$

$$i = i - a(i) \quad == \quad i = 1 - a(1) \quad == \quad i = 1 - (-1) = 2$$

Eksamen 2005

a)

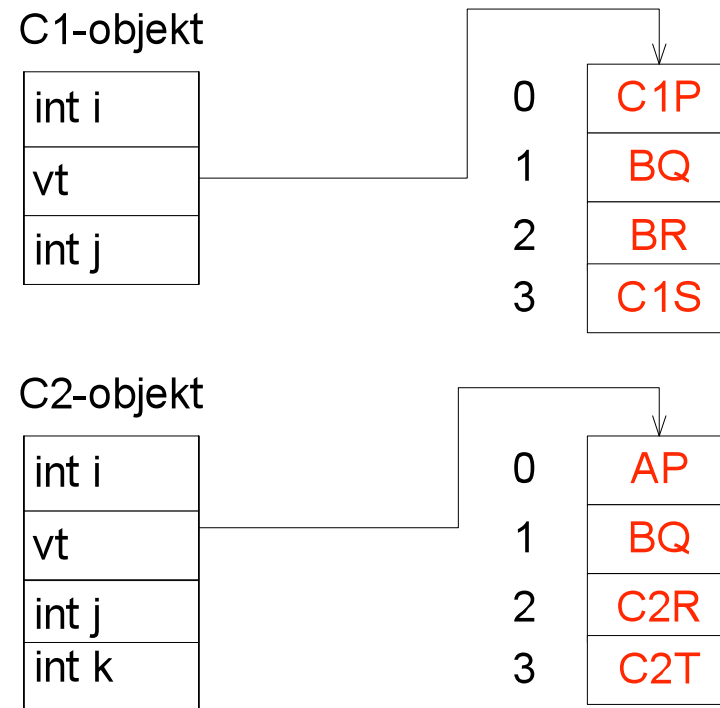

Eksamen 2005

b)

Vi finner nå på å innføre i språket muligheten for å spesifisere en metode til å være **final**. Det skal bety at den ikke lenger er virtuell, dvs at den ikke kan redefineres i subklasser.

Anta at vi i klassen B spesifiserer metoden Q til å være **final**.

Må vi da endre på virtuell-tabellen for B-objekter?

Begrund svaret.

NEI, virtuelle metoder i B-objekter kan fremdeles kaldes via A-typede pekere.

Eksamen 2005

c)

```
instanceOf = false;
cd= <refExpr>.cl;
while not(cd= klasedeskriptor for klassen Object) do
  { if cd= klasedeskriptor for klassen <class>
    then instanceOf= true;
    cd= cd.cl
  }
```

Eksamen 2005

d)

Generell test:

- Sjekk at `<class>.subklassenivå` ligger innenfor grensene på den aktuelle supers-tabellen
- `<refExpr>.vt.cl.supers[<class>.subklassenivå] = <class>`

Konkrete tester:

```
rc11.vt.cl.supers(3) = C1    dvs C1 = C1    dvs true
rc11.vt.cl.supers(3) = C2    dvs C1 = C2    dvs false
```

Eksamen 2005

d) Supers for C11 og C21

0	Object
1	A
2	B
3	C1
4	C11

0	Object
1	A
2	B
3	C2
4	C21