

# Class Diagram Summary

## Class

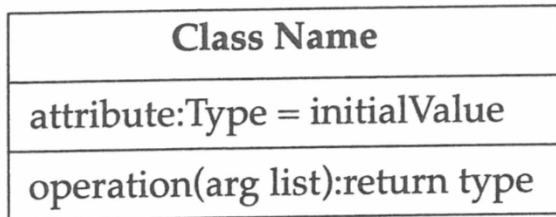

## Generalization

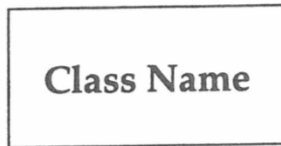
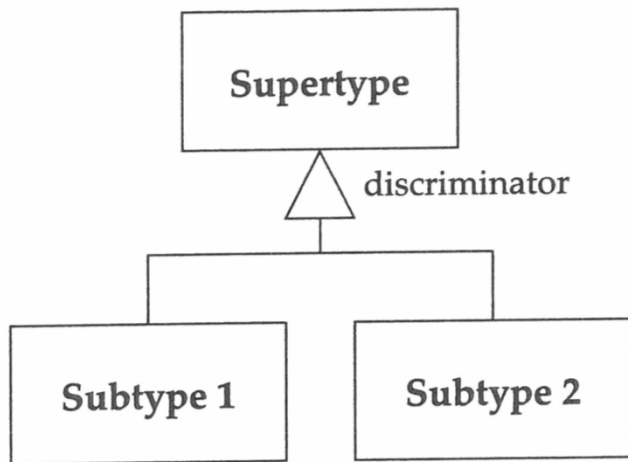

## Association

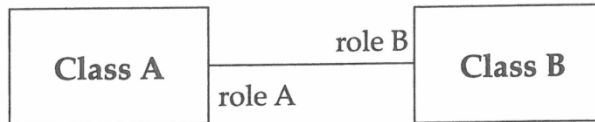

## Multiplicities

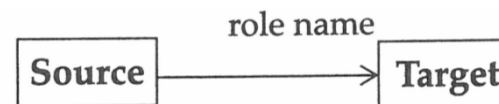
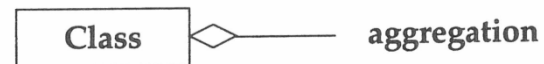
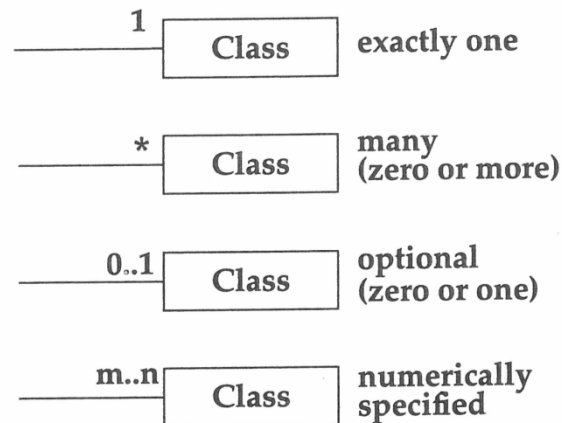

# Exercise: Represent the drawing below in UML

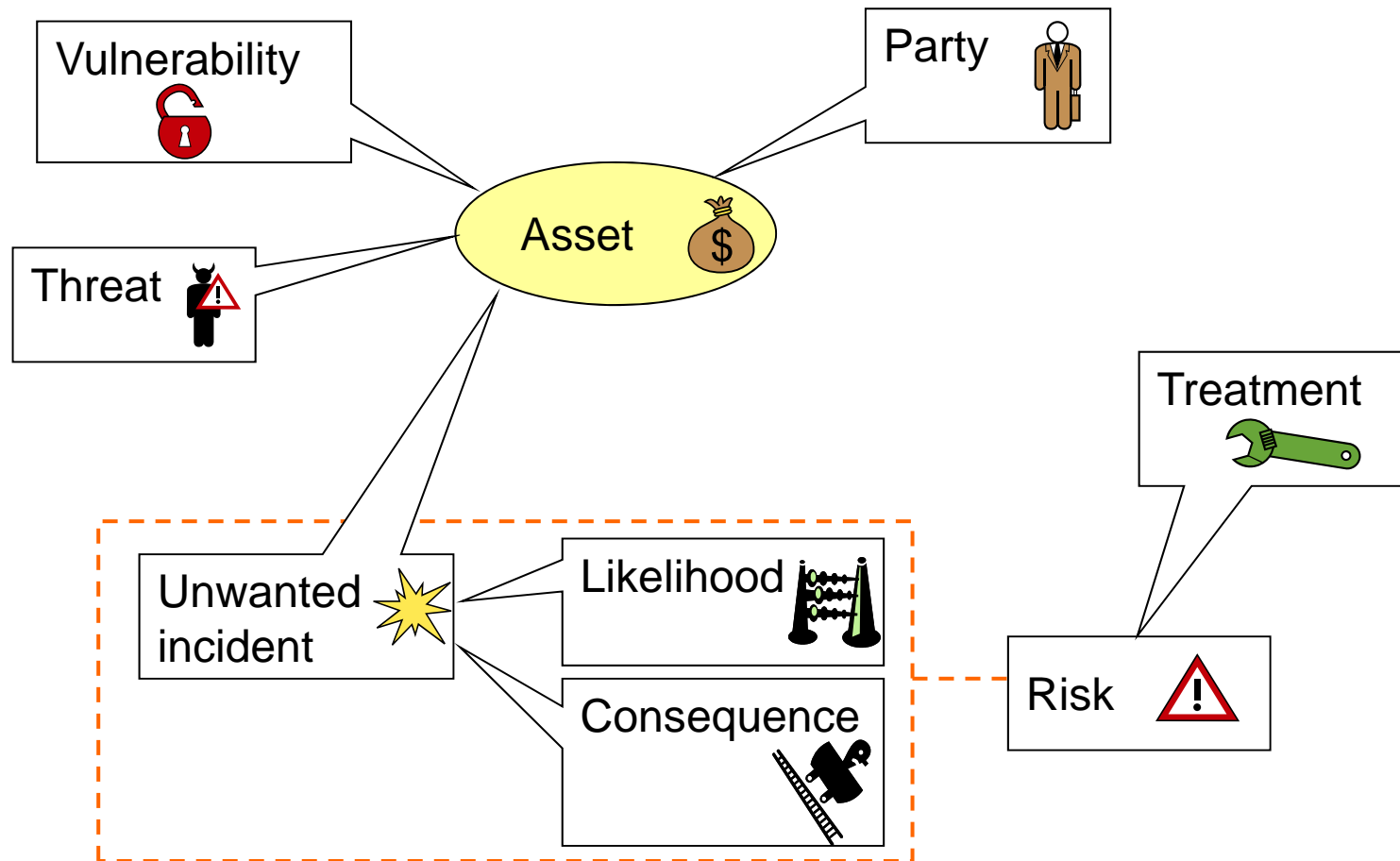

# Model using UML class diagram

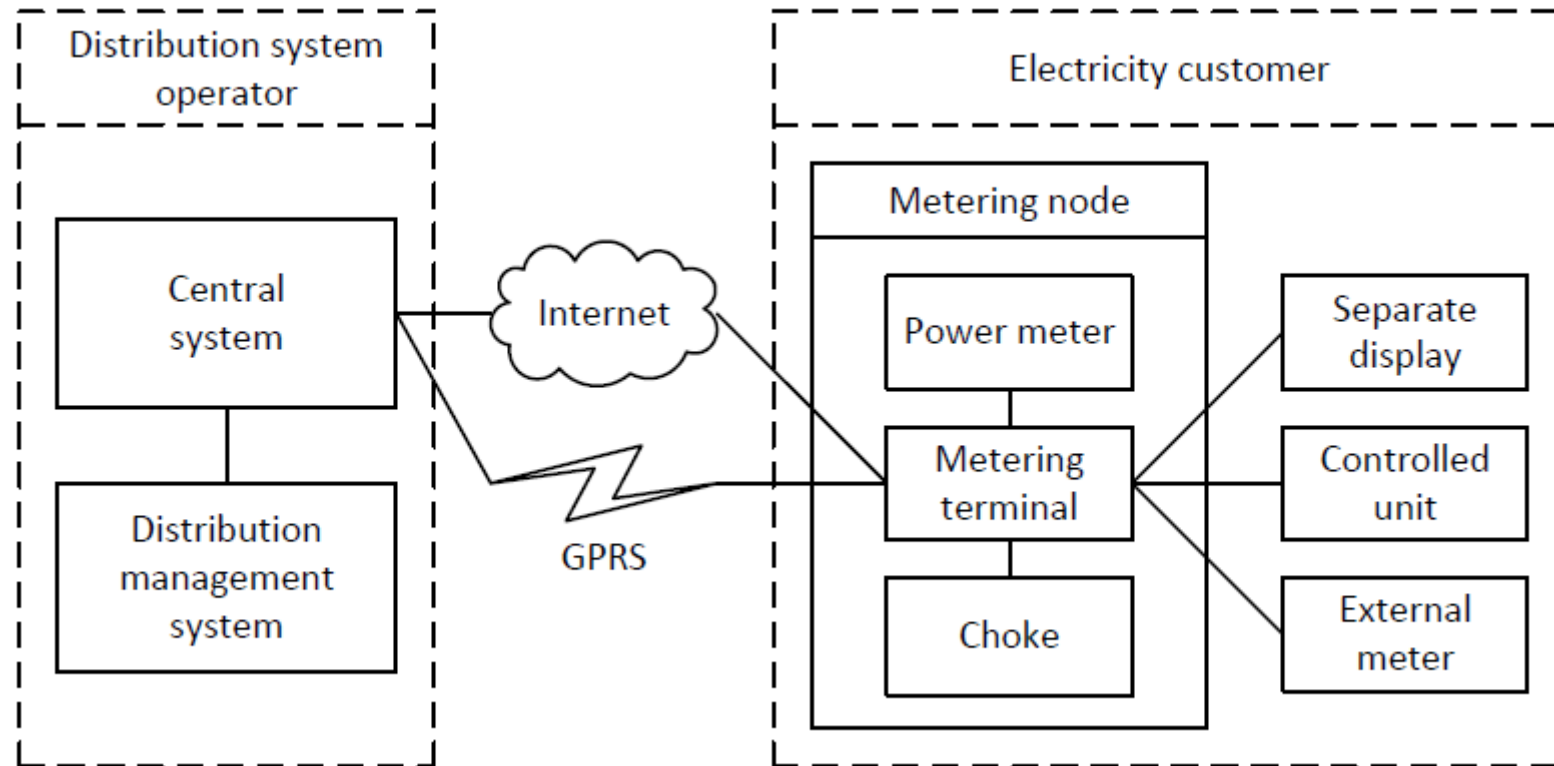

# Model using UML class diagrams

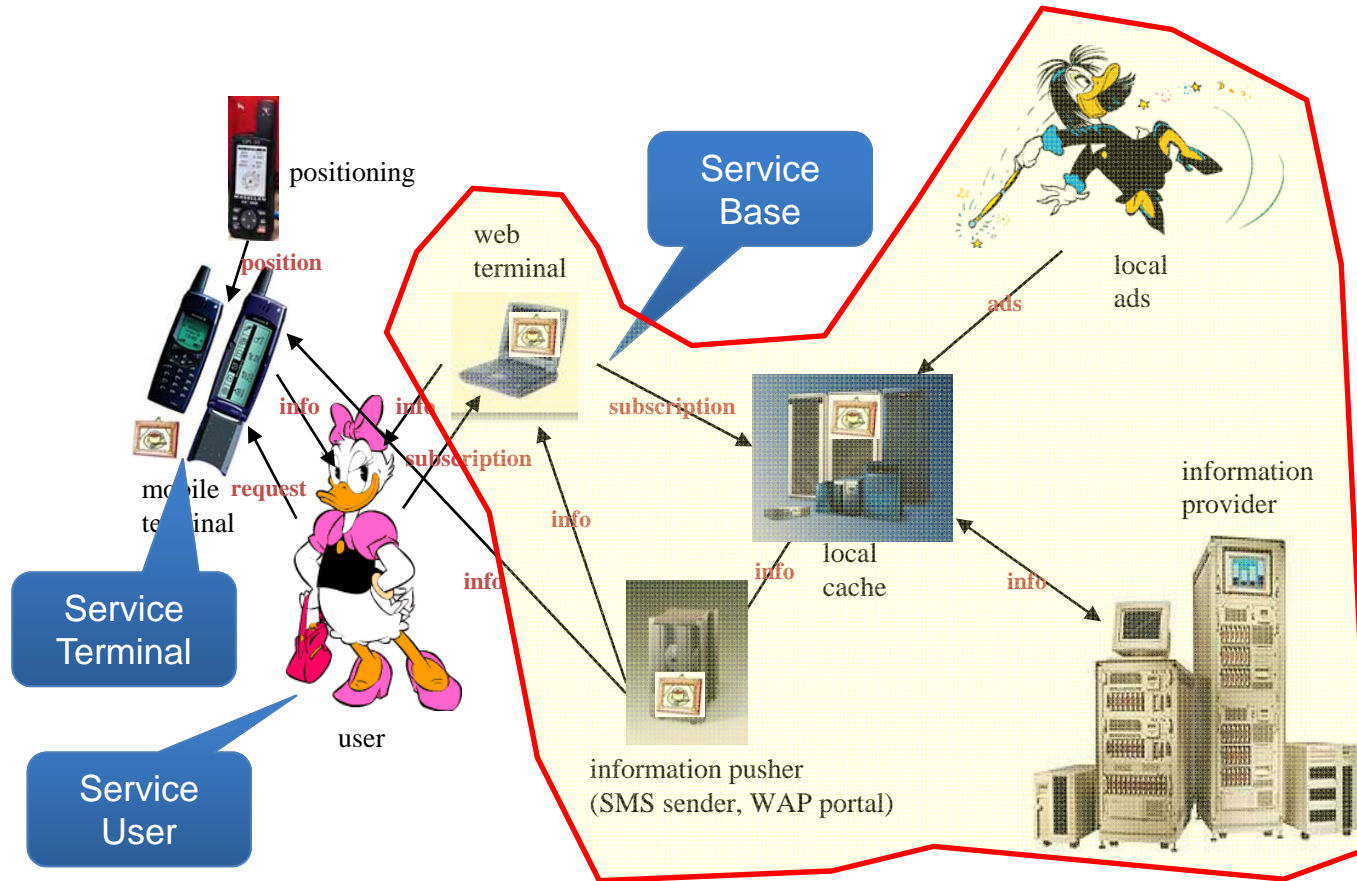

# Identify major threat profiles

- Describe them in terms of resources, ability, intention