Lecture 1 – Introduction to cryptography

TEK4500

24.08.2022

Håkon Jacobsen

hakon.jacobsen@its.uio.no

What is cryptography?

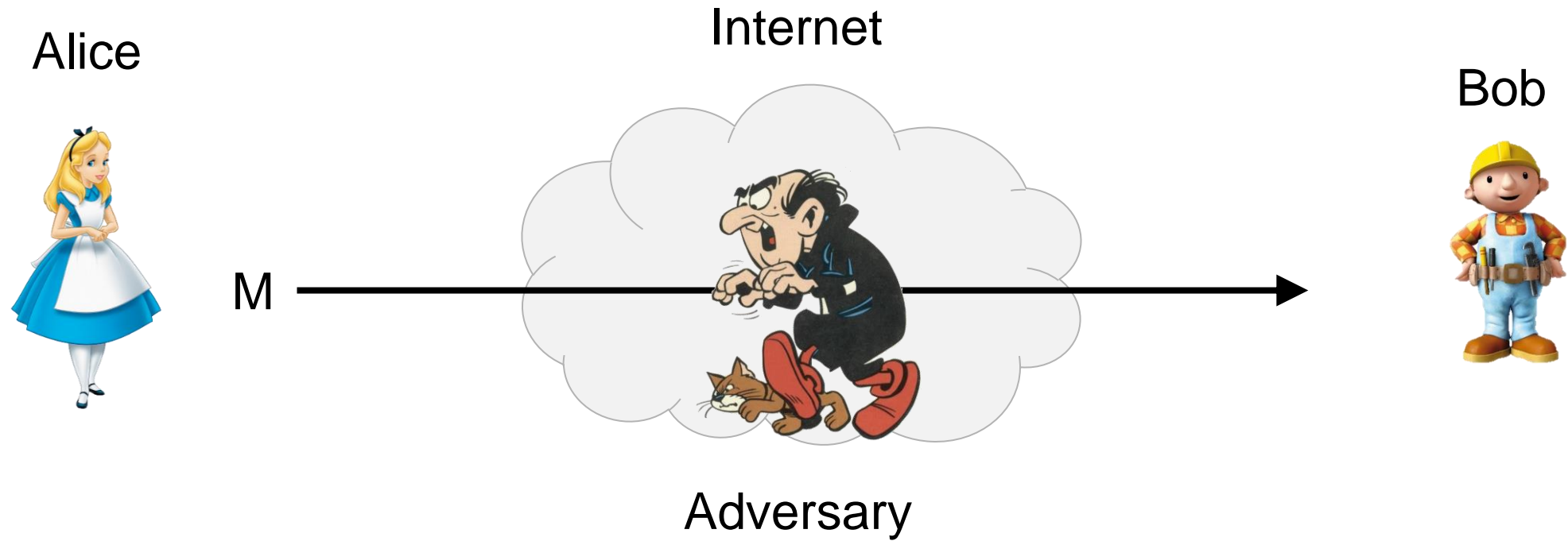

What is cryptography?



What is cryptography?

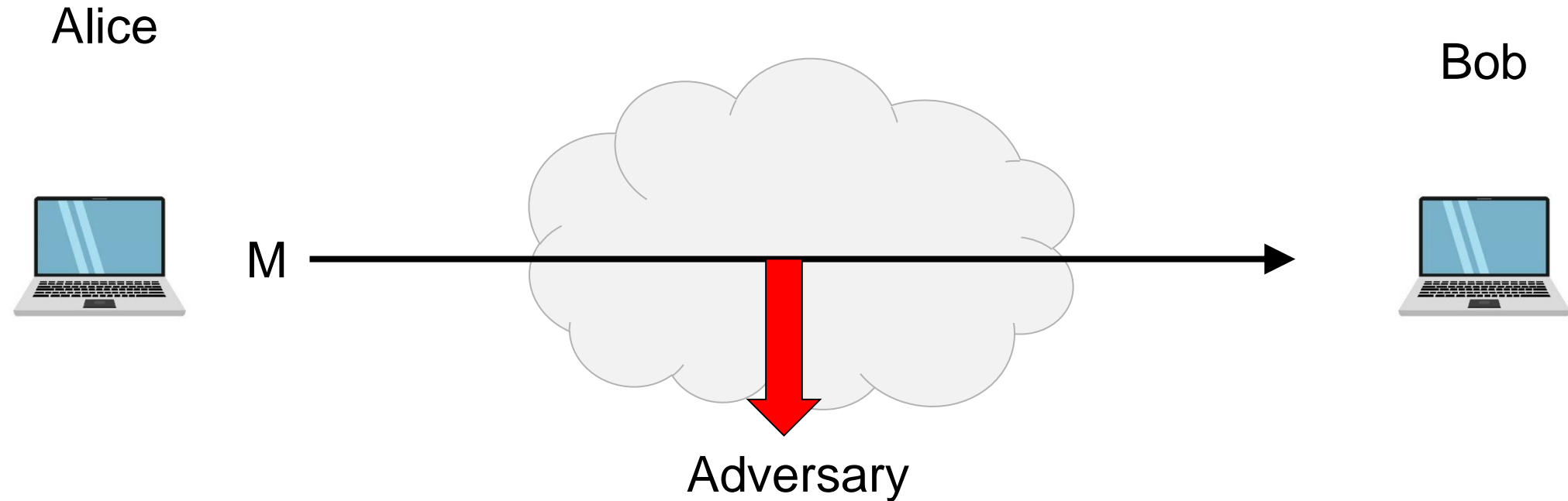

Security goals:

- **Data privacy:** adversary should not be able to *read* message M

What is cryptography?

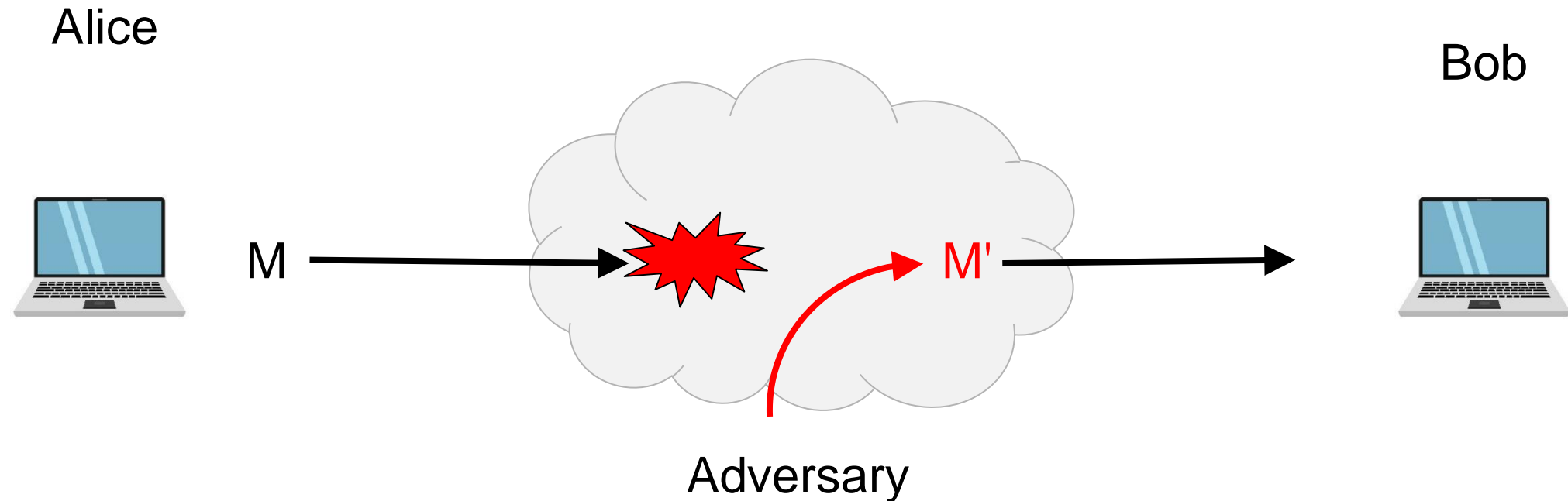

Security goals:

- **Data privacy:** adversary should not be able to *read* message M
- **Data integrity:** adversary should not be able to *modify* message M
- **Data authenticity:** message M really originated from Alice

Ideal solution: secure channels

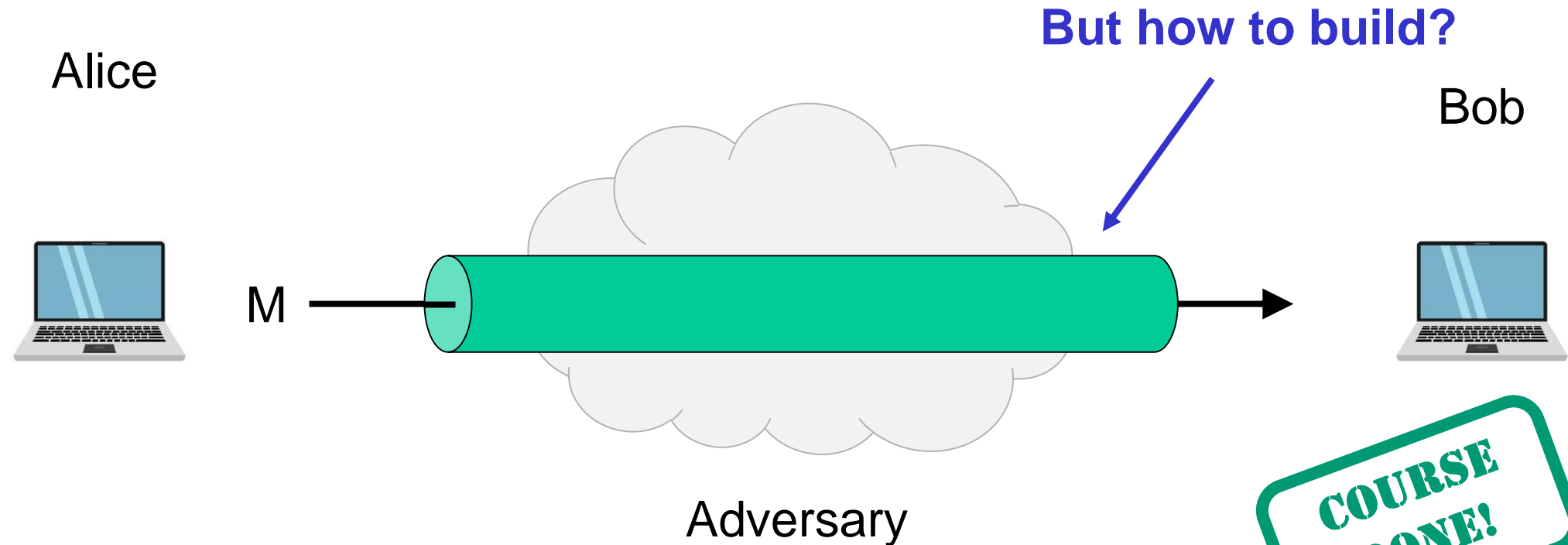

Security goals:

- **Data privacy:** adversary should not be able to *read* message M
- **Data integrity:** adversary should not be able to *modify* message M
- **Data authenticity:** message M really originated from Alice



Creating secure channels: encryption schemes

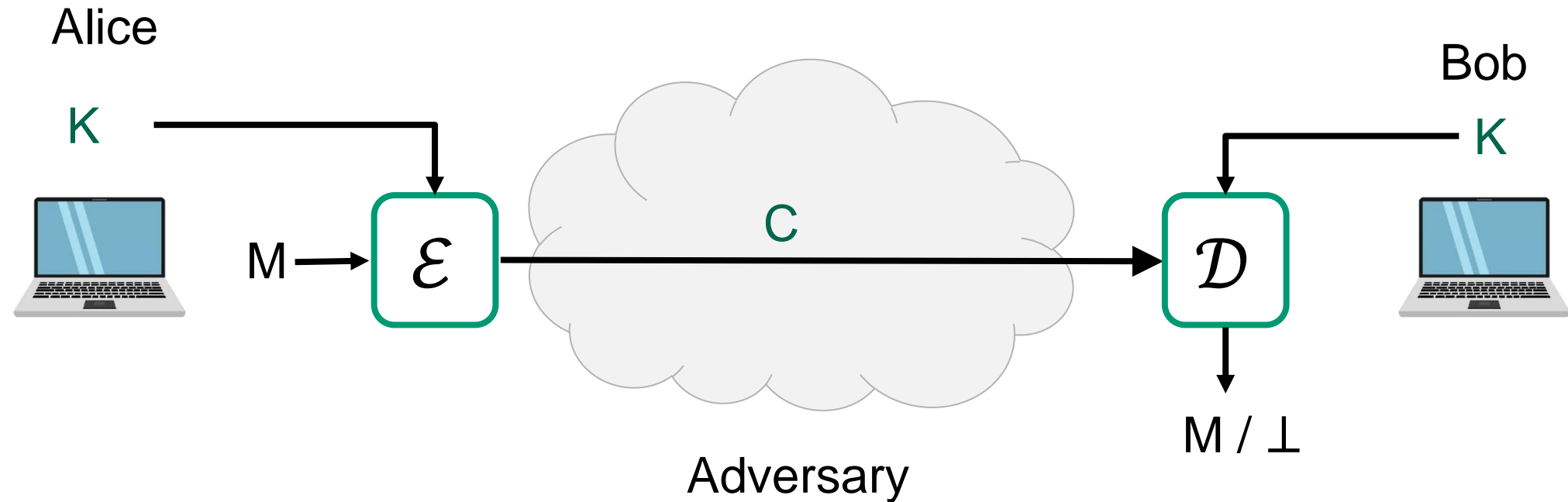

\mathcal{E} : encryption algorithm (public)

K : encryption / decryption key (secret)

\mathcal{D} : decryption algorithm (public)

Creating secure channels: encryption schemes

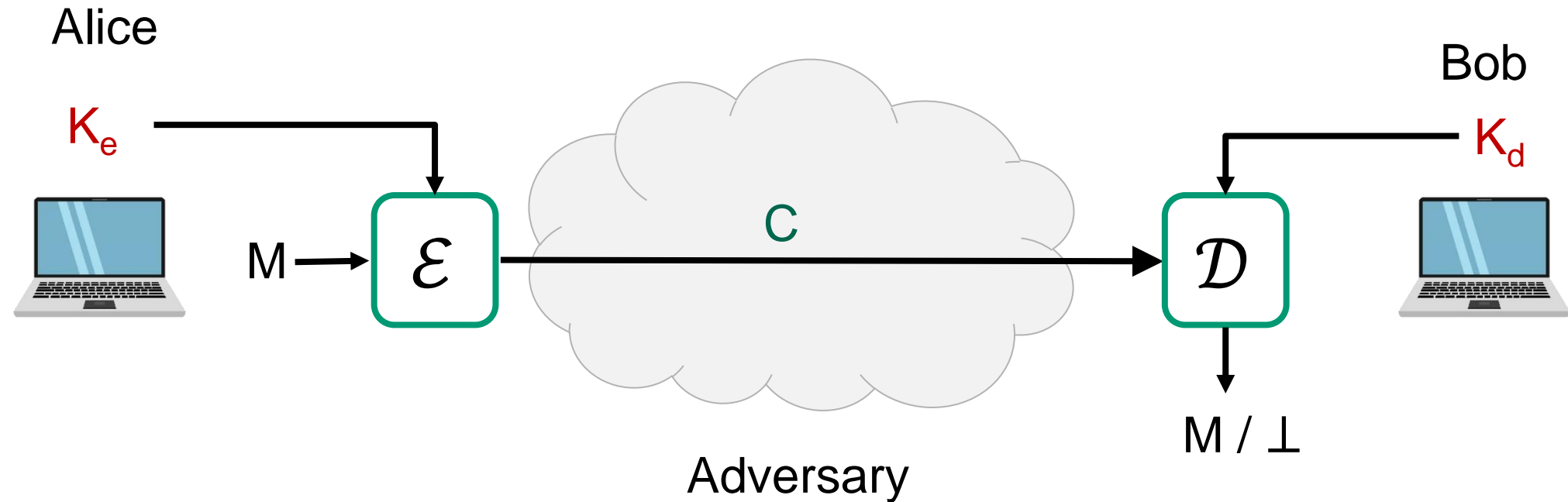

\mathcal{E} : encryption algorithm (public)

K_e : encryption key (public)

\mathcal{D} : decryption algorithm (public)

K_d : decryption key (secret)

Basic goals of cryptography

	Message privacy	Message integrity / authentication
Symmetric keys	Symmetric encryption	Message authentication codes (MAC)
Asymmetric keys	Asymmetric encryption (public-key encryption)	Digital signatures

Basic goals of cryptography

	Message privacy	Message integrity / authentication
Symmetric keys	Symmetric encryption	Message authentication codes (MAC)
Asymmetric keys	Asymmetric encryption (public-key encryption)	Digital signatures

Some notation

- \in – "element in"
 - $3 \in \{1,2,3,4,5\}$
 - $7 \notin \{1,2,3,4,5\}$
- $\{0,1\}^n$ – set of all bitstrings of length n
 - $011 \in \{0,1\}^3$
 - $011 \notin \{0,1\}^5$
- $\{0,1\}^*$ – set of all bitstrings of *finite* length
 - $1, 1001, 10, 10001101000001 \in \{0,1\}^*$
- $F : \mathcal{X} \rightarrow \mathcal{Y}$ – function from set \mathcal{X} to set \mathcal{Y}
 - $F : \{0,1\}^5 \rightarrow \{0,1\}^3$
 - $G : \{A, B, C, D\} \rightarrow \{0,1,2, \dots\}$
- \forall – "for all"
 - " $\forall X \in \{0,1\}^4 \dots$ " = "for all bitstrings of length 4..."
- \exists – "there exists"
 - " $\exists X \in \{0,1,2, \dots\}$ such that $X > 13$ "
- $\mathcal{X} \times \mathcal{Y}$ – set of pairs (X, Y) with $X \in \mathcal{X}$ and $Y \in \mathcal{Y}$
- $X \leftarrow 5$ – "assign value 5 to X "
- $X \overset{\$}{\leftarrow} \mathcal{X}$ – "assign X a *random* value from set \mathcal{X} "

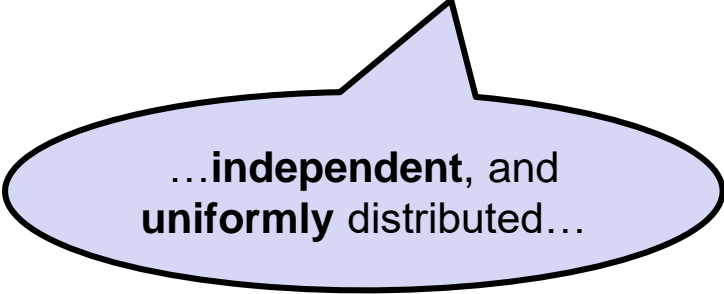

...independent, and
uniformly distributed...

Symmetric encryption – syntax

$$\Pi = (\mathcal{E}, \mathcal{D})$$

$$\mathcal{E} : \mathcal{K} \times \mathcal{M} \rightarrow \mathcal{C}$$

$$\mathcal{E}(K, M) = \mathcal{E}_K(M) = C$$

$$\mathcal{D} : \mathcal{K} \times \mathcal{C} \rightarrow \mathcal{M}$$

$$\mathcal{D}(K, C) = \mathcal{D}_K(C) = M$$

Examples:

$$\mathcal{K} = \{0,1\}^{128} \quad \mathcal{M} = \{0,1\}^* \quad \mathcal{C} = \{0,1\}^*$$

$$\mathcal{K} = \{0,1\}^{128} \quad \mathcal{M} = \{A, B, \dots, Z\} \quad \mathcal{C} = \{A, B, \dots, Z\}$$

$$\mathcal{K} = \{0,1\}^{128} \quad \mathcal{M} = \{\text{YES}, \text{NO}\} \quad \mathcal{C} = \{0,1\}^*$$

$$\mathcal{K} = \{1, \dots, p\} \quad \mathcal{M} = \{A, B, \dots, Z\} \quad \mathcal{C} = \{0,1\}^*$$

Correctness requirement:

$$\forall K \in \mathcal{K}, \forall M \in \mathcal{M}:$$

$$\mathcal{D}(K, \mathcal{E}(K, M)) = M$$

Possible privacy security goals:

- Hard to recover M from C
- Hard to recover K from C
- Hard to learn one bit of M from C
- Hard to learn parity of M from C
- ...



	A	B	C	D	E	F	G	H	I	J	K	L	M	N	O	P	Q	R	S	T	U	V	W	X	Y	Z
A	B	C	D	E	F	G	H	I	J	K	L	M	N	O	P	Q	R	S	T	U	V	W	X	Y	Z	
B	B	C	D	E	F	G	H	I	J	K	L	M	N	O	P	Q	R	S	T	U	V	W	X	Y	Z	A
C	C	D	E	F	G	H	I	J	K	L	M	N	O	P	Q	R	S	T	U	V	W	X	Y	Z	A	B
D	D	E	F	G	H	I	J	K	L	M	N	O	P	Q	R	S	T	U	V	W	X	Y	Z	A	B	C
E	E	F	G	H	I	J	K	L	M	N	O	P	Q	R	S	T	U	V	W	X	Y	Z	A	B	C	D
F	F	G	H	I	J	K	L	M	N	O	P	Q	R	S	T	U	V	W	X	Y	Z	A	B	C	D	E
G	G	H	I	J	K	L	M	N	O	P	Q	R	S	T	U	V	W	X	Y	Z	A	B	C	D	E	F
H	H	I	J	K	L	M	N	O	P	Q	R	S	T	U	V	W	X	Y	Z	A	B	C	D	E	F	G
I	I	J	K	L	M	N	O	P	Q	R	S	T	U	V	W	X	Y	Z	A	B	C	D	E	F	G	H
J	J	K	L	M	N	O	P	Q	R	S	T	U	V	W	X	Y	Z	A	B	C	D	E	F	G	H	I
K	K	L	M	N	O	P	Q	R	S	T	U	V	W	X	Y	Z	A	B	C	D	E	F	G	H	I	J
L	L	M	N	O	P	Q	R	S	T	U	V	W	X	Y	Z	A	B	C	D	E	F	G	H	I	J	K
M	M	N	O	P	Q	R	S	T	U	V	W	X	Y	Z	A	B	C	D	E	F	G	H	I	J	K	L
N	N	O	P	Q	R	S	T	U	V	W	X	Y	Z	A	B	C	D	E	F	G	H	I	J	K	L	M
O	O	P	Q	R	S	T	U	V	W	X	Y	Z	A	B	C	D	E	F	G	H	I	J	K	L	M	N
P	P	Q	R	S	T	U	V	W	X	Y	Z	A	B	C	D	E	F	G	H	I	J	K	L	M	N	O
Q	Q	R	S	T	U	V	W	X	Y	Z	A	B	C	D	E	F	G	H	I	J	K	L	M	N	O	P
R	R	S	T	U	V	W	X	Y	Z	A	B	C	D	E	F	G	H	I	J	K	L	M	N	O	P	Q
S	S	T	U	V	W	X	Y	Z	A	B	C	D	E	F	G	H	I	J	K	L	M	N	O	P	Q	R
T	T	U	V	W	X	Y	Z	A	B	C	D	E	F	G	H	I	J	K	L	M	N	O	P	Q	R	S
U	U	V	W	X	Y	Z	A	B	C	D	E	F	G	H	I	J	K	L	M	N	O	P	Q	R	S	T
V	V	W	X	Y	Z	A	B	C	D	E	F	G	H	I	J	K	L	M	N	O	P	Q	R	S	T	U
W	W	X	Y	Z	A	B	C	D	E	F	G	H	I	J	K	L	M	N	O	P	Q	R	S	T	U	V
X	X	Y	Z	A	B	C	D	E	F	G	H	I	J	K	L	M	N	O	P	Q	R	S	T	U	V	W
Y	Y	Z	A	B	C	D	E	F	G	H	I	J	K	L	M	N	O	P	Q	R	S	T	U	V	W	X
Z	Z	A	B	C	D	E	F	G	H	I	J	K	L	M	N	O	P	Q	R	S	T	U	V	W	X	Y



Historical encryption algorithms

Ceasar cipher

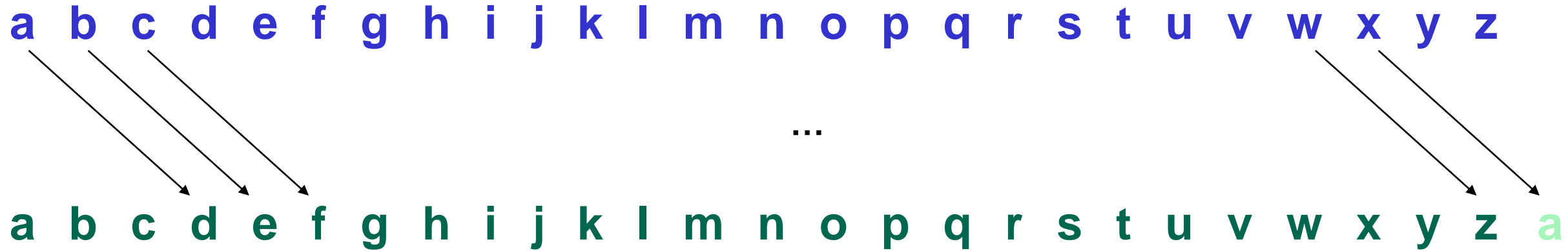

in the far distance a helicopter skimmed down between the roofs, hovered for an instant like a bluebottle, and darted away again with a curving flight. It was the police patrol, snooping into people's windows

lq wkh idu glvwdqfh d kholfrswhu vnlpphg grzq ehwzhhq
wkh urriv, kryhuhg iru dq lqvwdqw olnh d eoxherwwoh,
dqg gduwhg dzdb djdlq zlwk d fxuylqj ioljkw. Lw zdv
wkh srolfh sdwuro, vqrrslqj lqwr shrsoh'v zlqgrzv

Ceasar cipher (ROT-13)

a b c d e f g h i j k l m n o p q r s t u v w x y z

a b c d e f g h i j k l m n o p q r s t u v w x y z

in the far distance a helicopter skimmed down between
the roofs, hovered for an instant like a bluebottle,
and darted away again with a curving flight. It was
the police patrol, snooping into people's windows

va gur sne qvfgnapr n uryvpbcgre f xvzzrq qbja orgjrra
gur ebbsf, ubirerq sbe na vafgnag yvxr n oyhrobggyr,
naq qnegrq njnl ntnva jvgu n pheivat syvtug. Vg jnf
gur cbyvpr cngeby, fabbcvat vagb crbcyr'f jvaqbjf

Ceasar cipher

- $a \leftrightarrow 0$
- $b \leftrightarrow 1$
- $c \leftrightarrow 2$
- $d \leftrightarrow 3$
- $e \leftrightarrow 4$

$$C \leftarrow M + 3 \pmod{26}$$

⋮

- $z \leftrightarrow 25$

Modular arithmetic

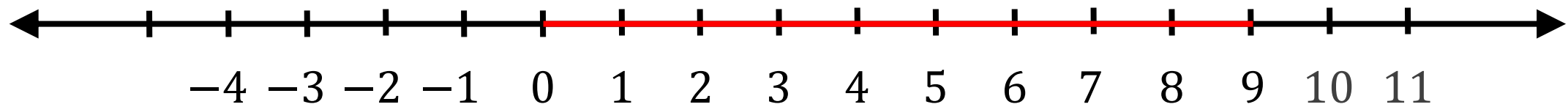

Modular arithmetic

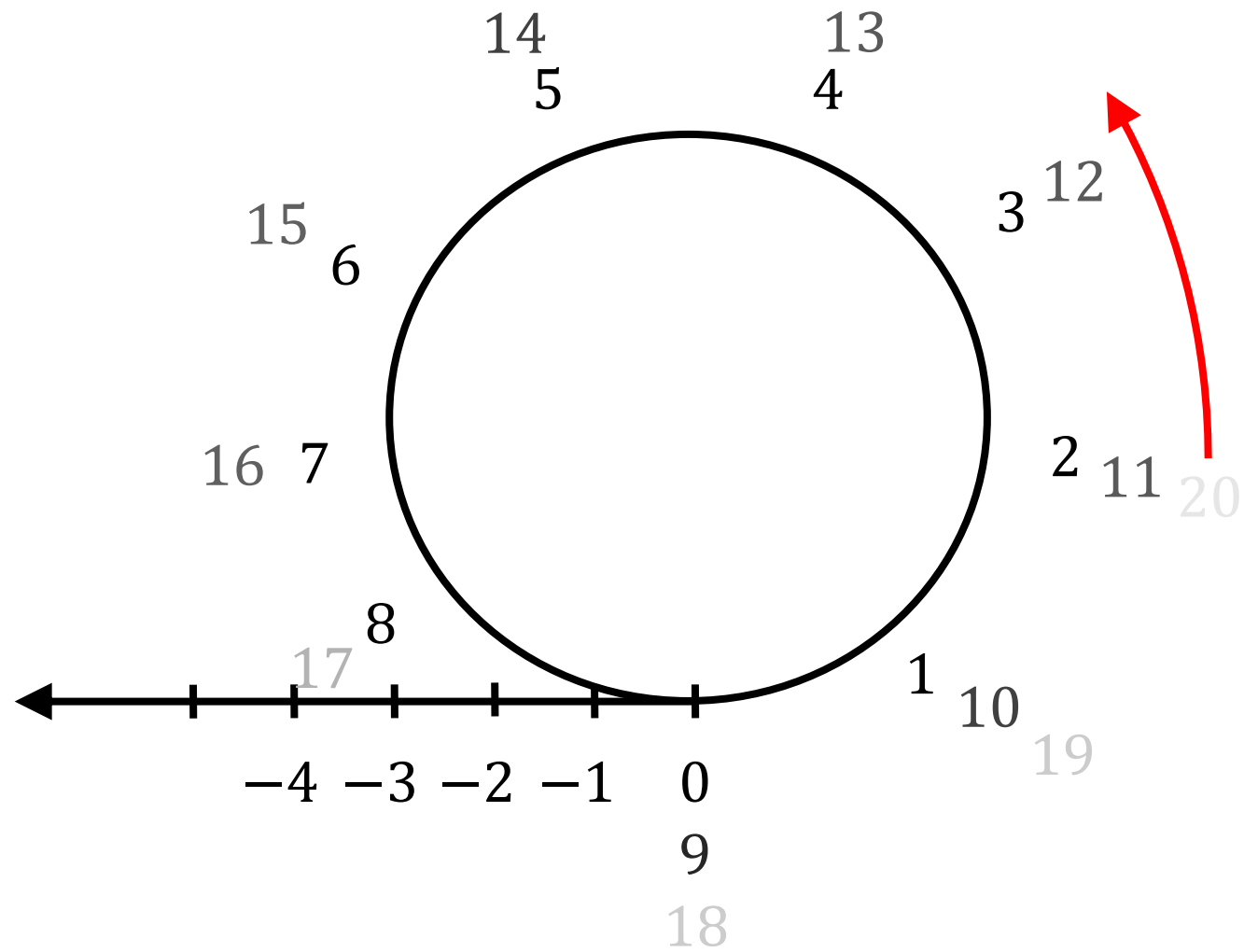

Modular arithmetic

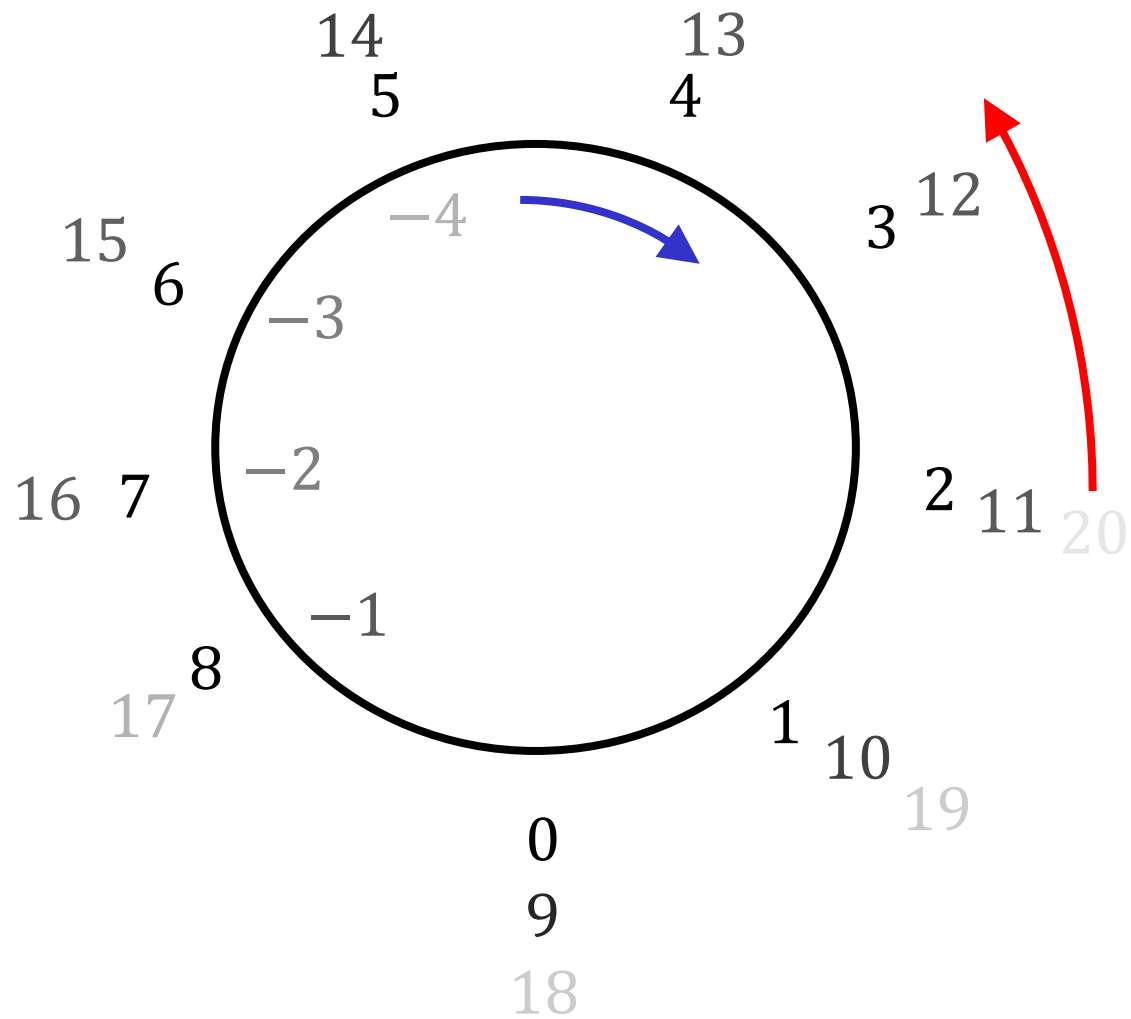

Modular arithmetic

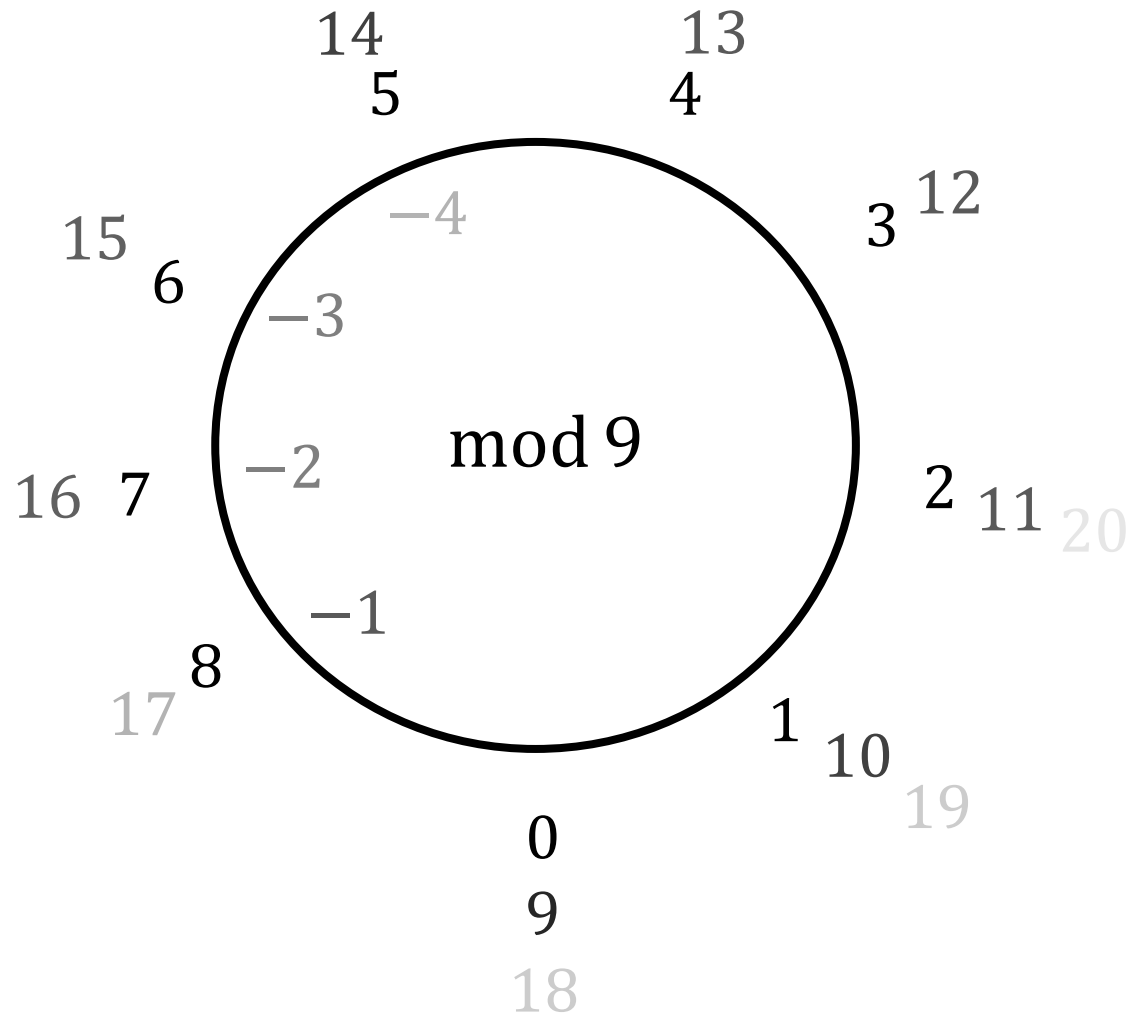

$$1 + 3 = 4$$

$$5 + 8 = 13 \equiv 4 \pmod{9}$$

$$5 \cdot 4 = 20 \equiv 2 \pmod{9}$$

$$2 - 5 = -3 \equiv 6 \pmod{9}$$

$$2^{10} = 1024 \equiv 7 \pmod{9}$$

$$158 = 153 + r \equiv r \pmod{9} \equiv 5 \pmod{9}$$

$$r < 9$$

$$9 \rightarrow 18 \rightarrow 27 \rightarrow 36 \rightarrow \dots \rightarrow \mathbf{153} \rightarrow 162$$

Ceasar cipher

- $a \leftrightarrow 0$
- $b \leftrightarrow 1$
- $c \leftrightarrow 2$
- $d \leftrightarrow 3$
- $e \leftrightarrow 4$

- \vdots

- $z \leftrightarrow 25$

$$C \leftarrow M + 3 \pmod{26}$$

ROT-13

- $a \leftrightarrow 0$
- $b \leftrightarrow 1$
- $c \leftrightarrow 2$
- $d \leftrightarrow 3$
- $e \leftrightarrow 4$
- \vdots
- $z \leftrightarrow 25$

$$C \leftarrow M + 13 \pmod{26}$$

$$M \leftarrow C - 13 \pmod{26}$$

$$\mathcal{K} = \{ \}$$

$$\mathcal{E} : \mathcal{K} \times \mathcal{M} \rightarrow \mathcal{C}$$

$$\mathcal{M} = \{0, 1, 2, \dots, 25\}$$

$$\mathcal{D} : \mathcal{K} \times \mathcal{C} \rightarrow \mathcal{M}$$

$$\mathcal{C} = \{0, 1, 2, \dots, 25\}$$

ROT-K

- $a \leftrightarrow 0$
- $b \leftrightarrow 1$
- $c \leftrightarrow 2$
- $d \leftrightarrow 3$
- $e \leftrightarrow 4$
- \vdots
- $z \leftrightarrow 25$

$$C \leftarrow M + K \pmod{26}$$

$$M \leftarrow C - K \pmod{26}$$

$$\mathcal{K} = \{0, 1, 2, \dots, 25\}$$

$$\mathcal{M} = \{0, 1, 2, \dots, 25\}$$

$$\mathcal{C} = \{0, 1, 2, \dots, 25\}$$

$$\mathcal{E} : \mathcal{K} \times \mathcal{M} \rightarrow \mathcal{C}$$

$$\mathcal{D} : \mathcal{K} \times \mathcal{C} \rightarrow \mathcal{M}$$

Attacking ROT-K

$$|\mathcal{K}| = 26$$

<i>K</i>	<i>M</i>
0	va gur sne qvfgnapr n uryvpbcgre ...

C = va gur sne qvfgnapr n uryvpbcgre ...

Conclusion: key space must be large enough!

Substitution cipher

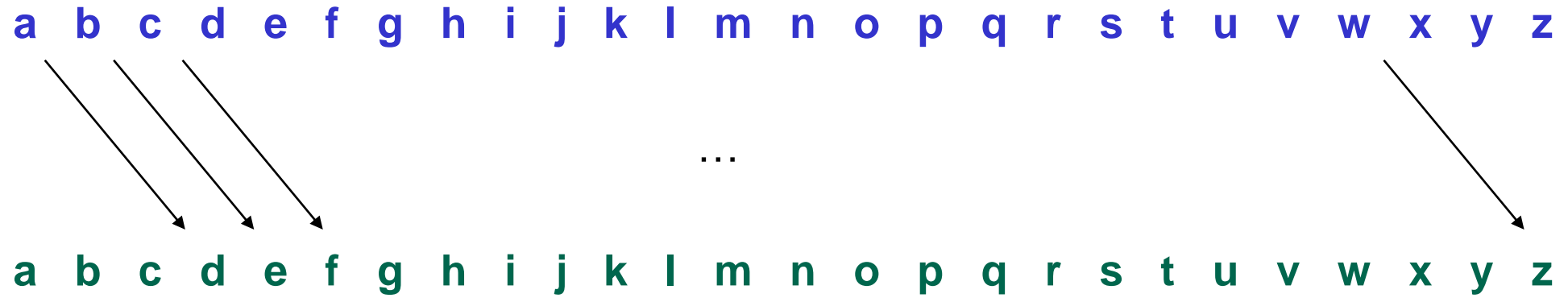

Substitution cipher

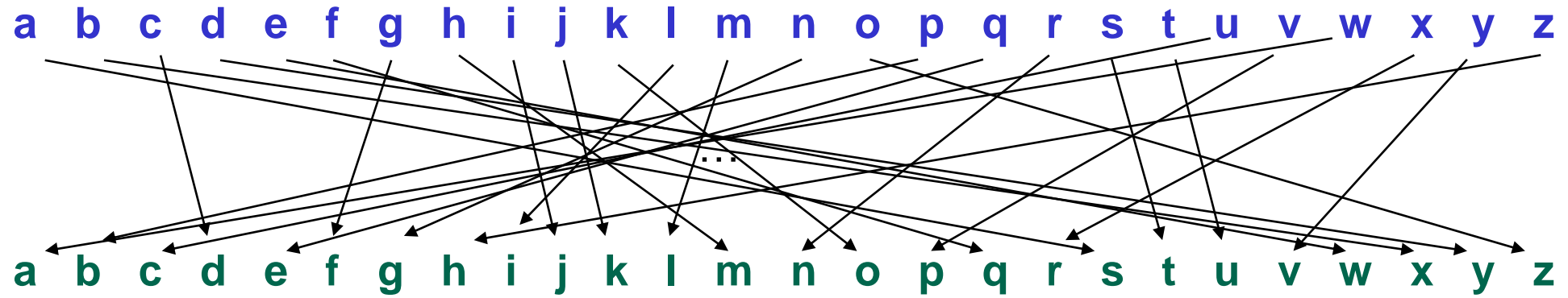

Substitution cipher

$$|\mathcal{K}| = 26! \approx 10^{26} \approx 2^{88}$$

a b c d e f g h i j k l m n o p q r s t u v w x y z

↕ ↕ ↕ ↕

...

↕

s x d y w q f m j k o i l g z b e n t u c p a r v h

in the far distance a helicopter skimmed down between the roofs,
hovered for an instant like a bluebottle, and darted away again
with a curving flight. It was the police patrol, snooping into
people's windows

jg umw qsn yjtusgdw s mwijdzbuwn tojllwy yzag xwuawwg umw nzzqt,
mzpwnwy qzn sg jgtusgu ijow s xicwxzuuiw, sgy ysnuwy sasv sfsjg
ajum s dcnpjgf qijfmu. ju ast umw bzijdw bsunzi, tgzzbjgf jguz
bwzbiw't ajgyzat

Attacking the substitution cipher

$$|\mathcal{K}| = 26! \approx 10^{26} \approx 2^{88}$$

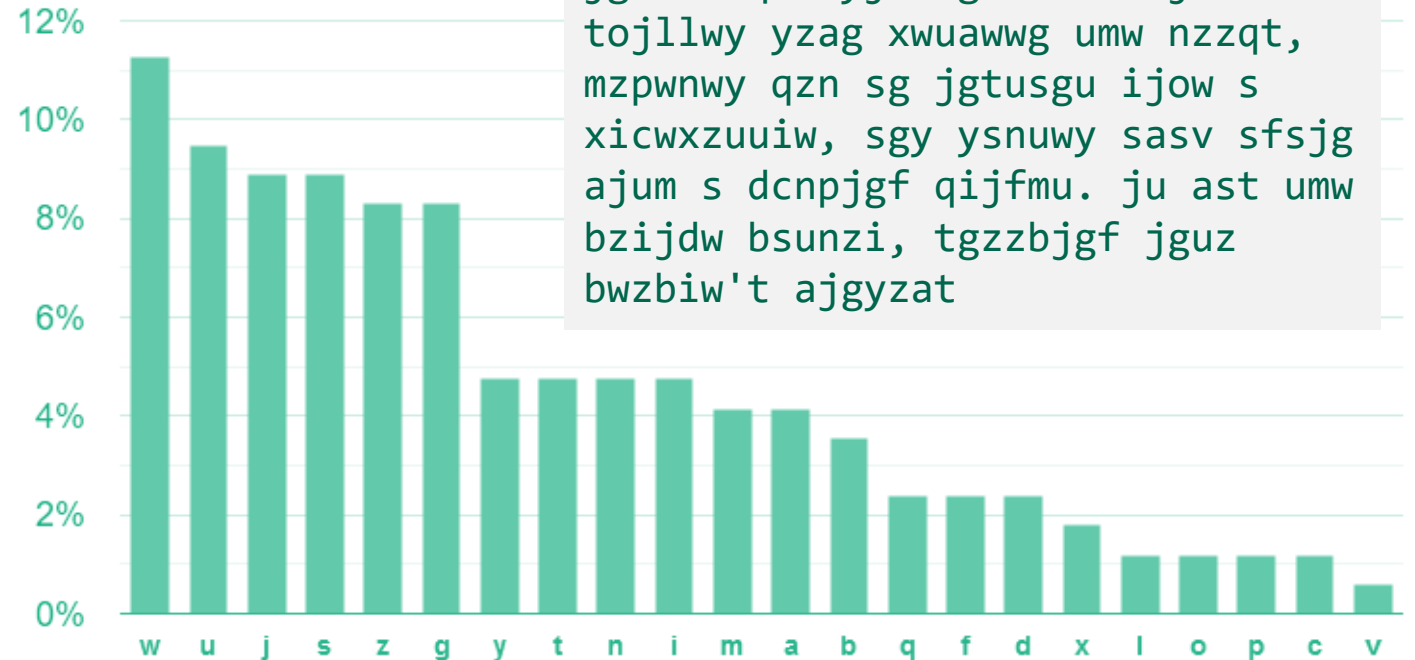
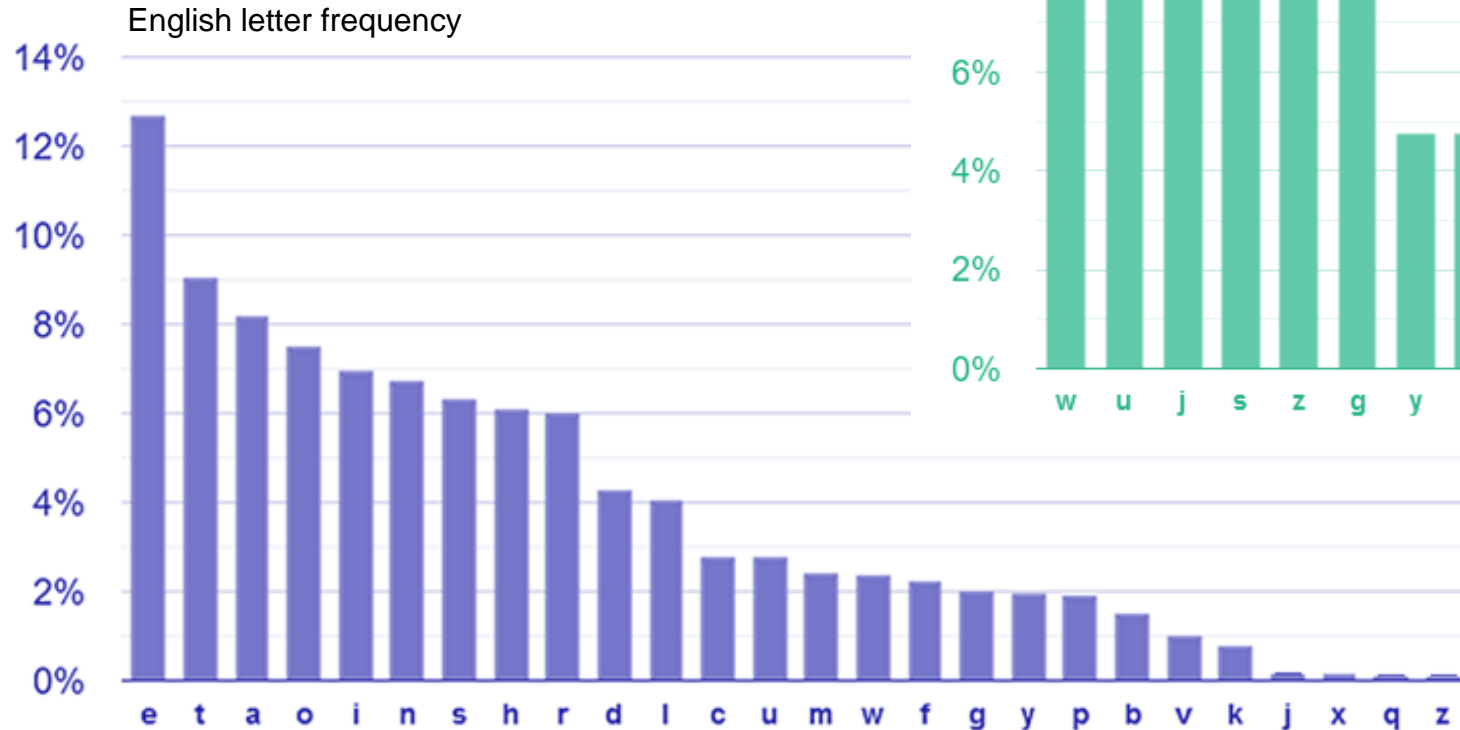

jg umw qsn yjtusgdw s mwjdzbuwn
tojllwy yzag xwuawwg umw nzzqt,
mzpwnwy qzn sg jgtusgu ijow s
xicwxzuuiw, sgy ysnuwy sasv sfsjg
ajum s dcnpjgf qijfmu. ju ast umw
bzjdw bsunzi, tgzzbjgf jguz
bwzbiw't ajgyzat

Attacking the substitution cipher

$$|\mathcal{K}| = 26! \approx 10^{26} \approx 2^{88}$$

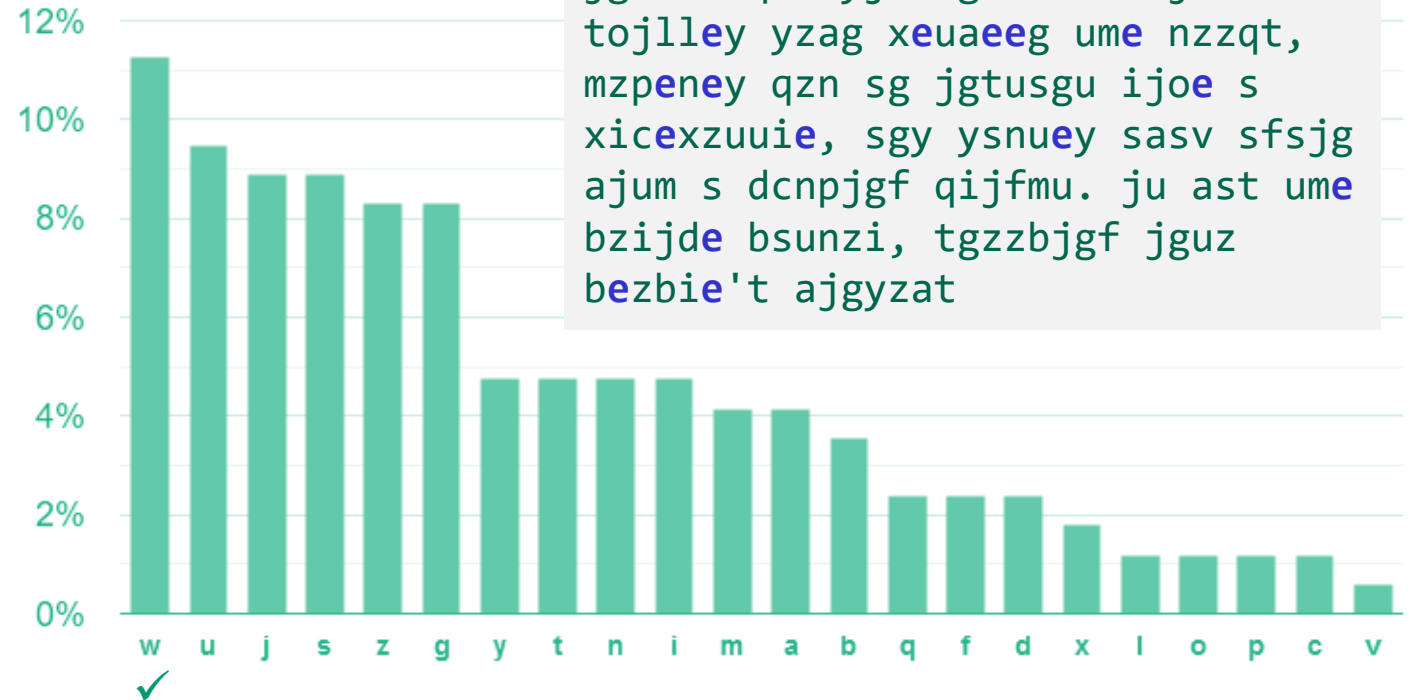
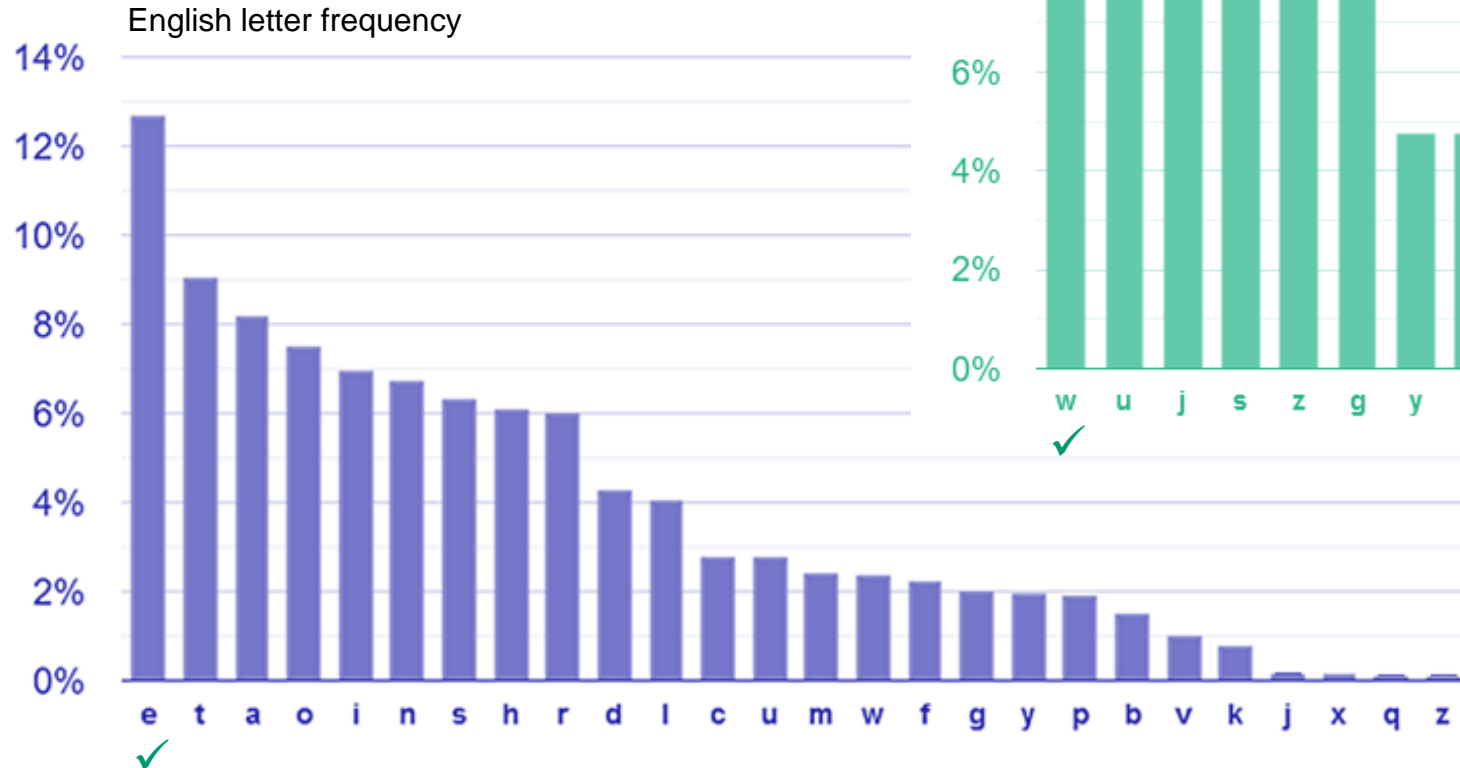

jg ume qsn yjtusgde s meijdzbuen
 tojlley yzag xeuaeeg ume nzzqt,
 mzpeney qzn sg jgtusgu ijoe s
 xicexzuuie, sgy ysnu ey sasv sfsjg
 ajum s dcnpjgf qijfmu. ju ast ume
 bzijde bsunzi, tgzzbjgf jguz
 bezbie't ajgyzat

Attacking the substitution cipher

$$|\mathcal{K}| = 26! \approx 10^{26} \approx 2^{88}$$

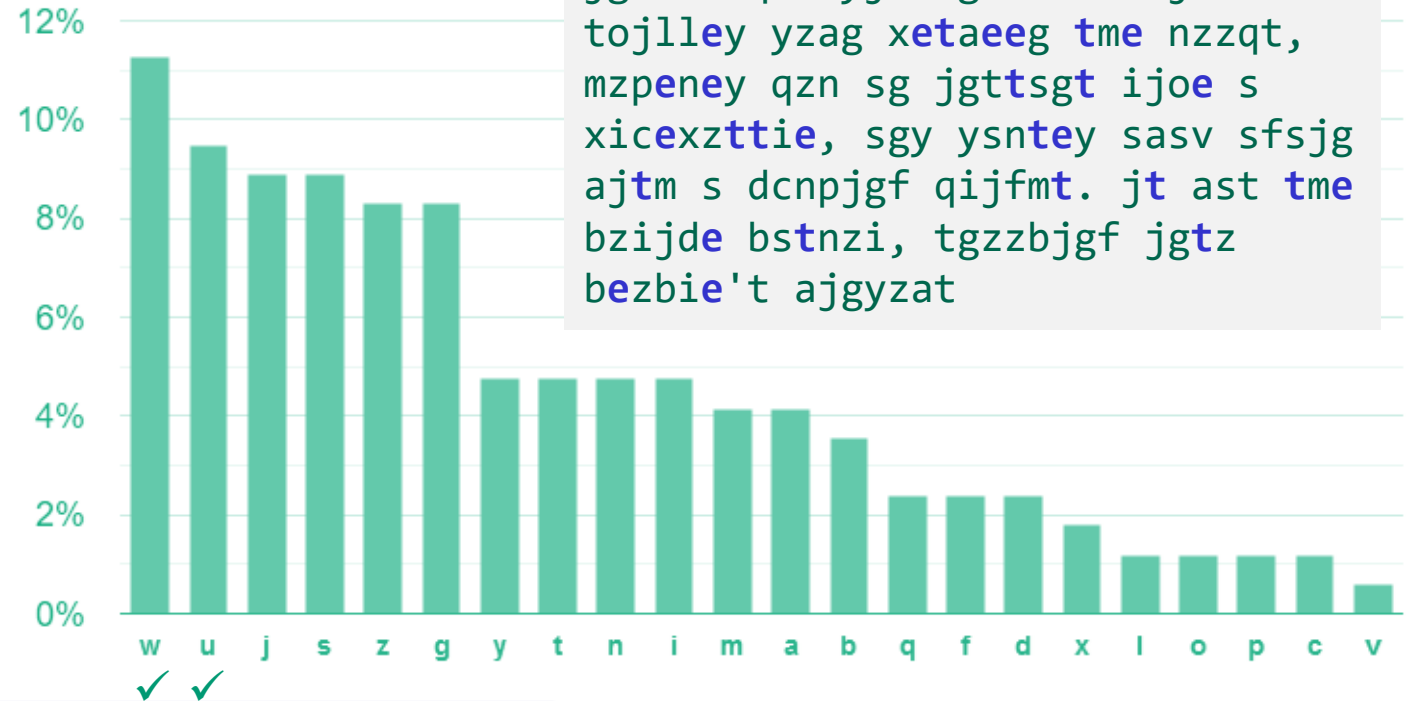
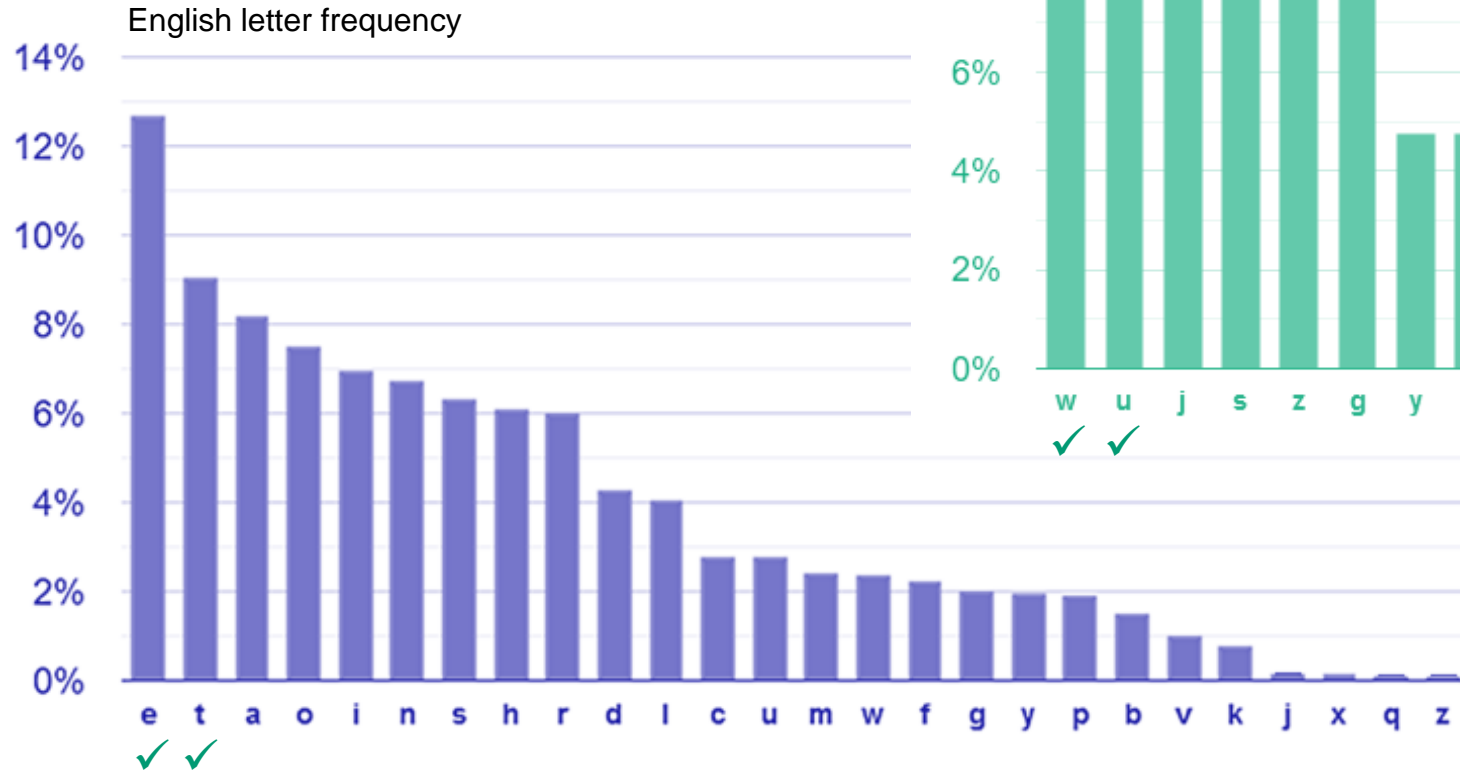

jg tme qsn yjttsjde s meijdzbt
 tojlley yzag xetaeeg tme nzzqt,
 mzpeney qzn sg jgttsgt ijoe s
 xicexzttie, sgy ysntey sasv sfsjg
 ajtm s dcnpjgf qijfmt. jt ast tme
 bzijde bstnzi, tgzzbjgf jgtz
 bezbie't ajgyzat

Attacking the substitution cipher

$$|\mathcal{K}| = 26! \approx 10^{26} \approx 2^{88}$$

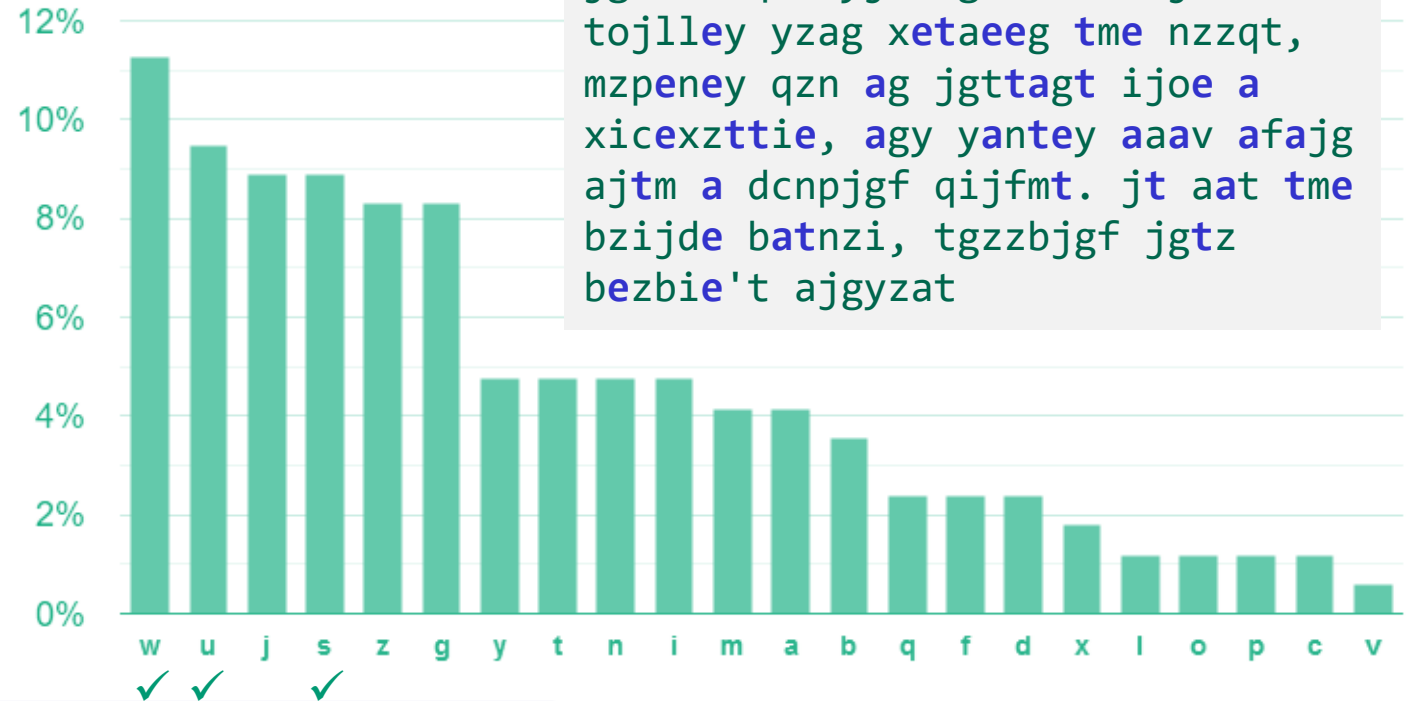
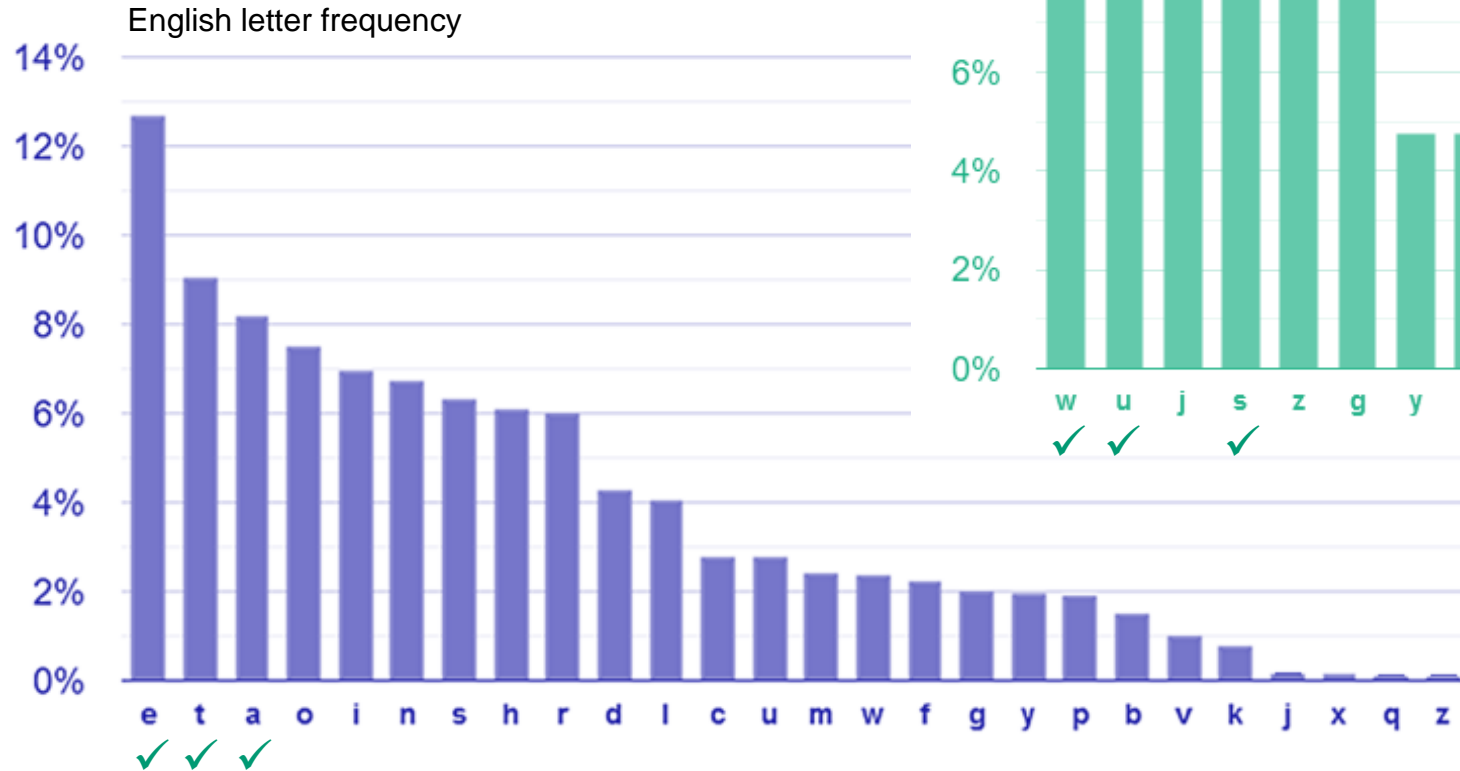

jg tme qan yjttagde a meijdzbten
 tojlley yzag xetaeeg tme nzzqt,
 mzpeney qzn ag jgtagt ijoe a
 xicexztie, agy yantey aaav afajg
 ajtm a dcnpjgf qijfmt. jt aat tme
 bzijde batnzi, tgzzbjgf jgtz
 bezbie't ajgyzat

Attacking the substitution cipher

$$|\mathcal{K}| = 26! \approx 10^{26} \approx 2^{88}$$

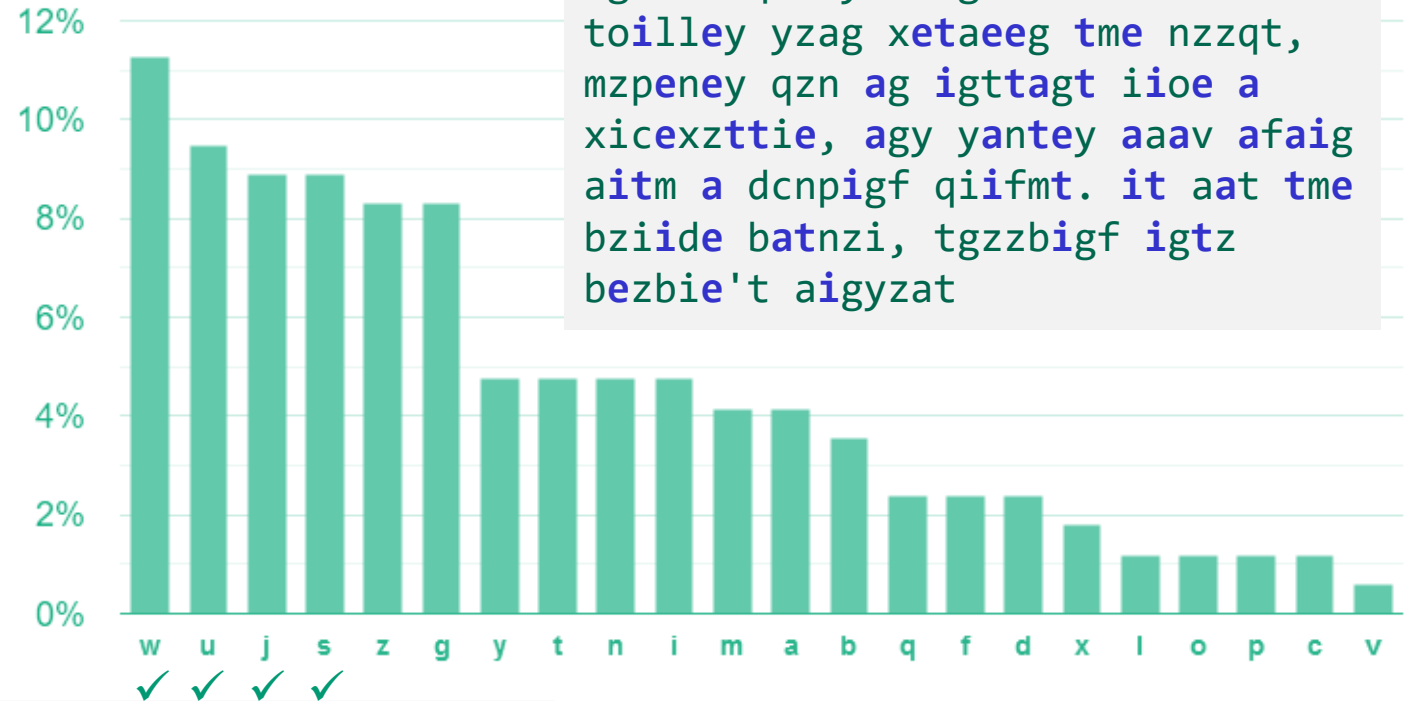
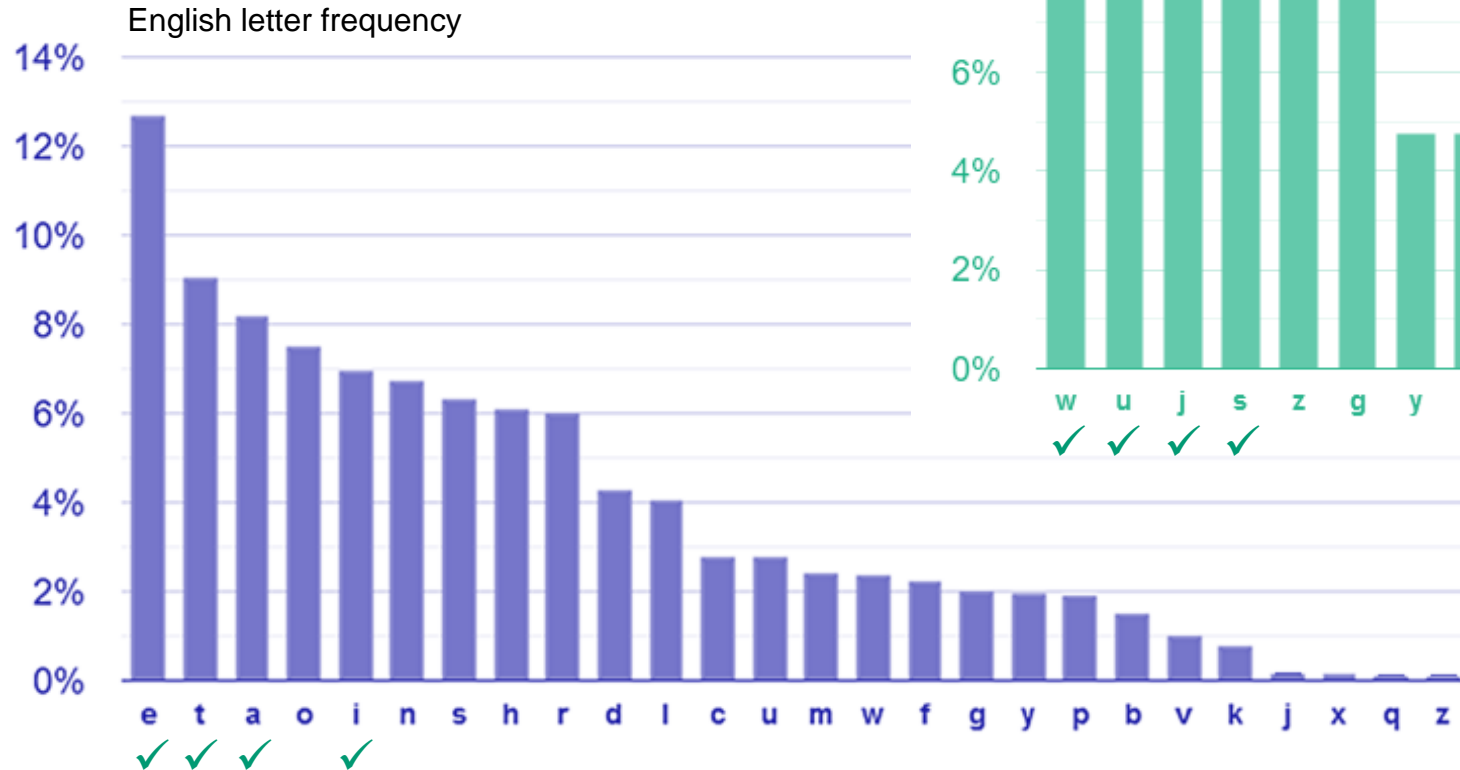

ig tme qan yittagde a meiidzbten
 toille yzag xetaeeg tme nzzqt,
 mzpeney qzn ag igttagt iioe a
 xicexzttie, agy yantey aaav afaig
 aitm a dcnpigf qiifmt. it aat tme
 bziide batnzi, tgzzbigf igtz
 bezbie't aigyzat

Attacking the substitution cipher

$$|\mathcal{K}| = 26! \approx 10^{26} \approx 2^{88}$$

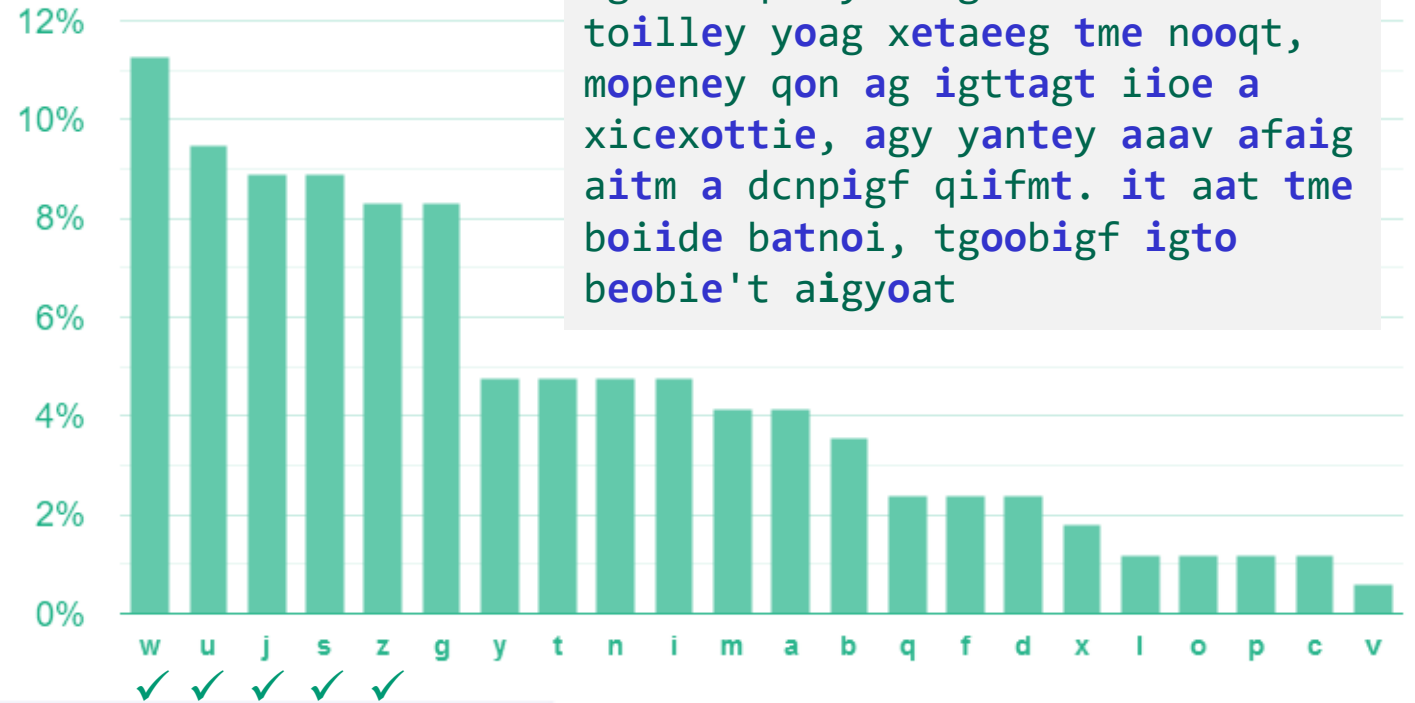
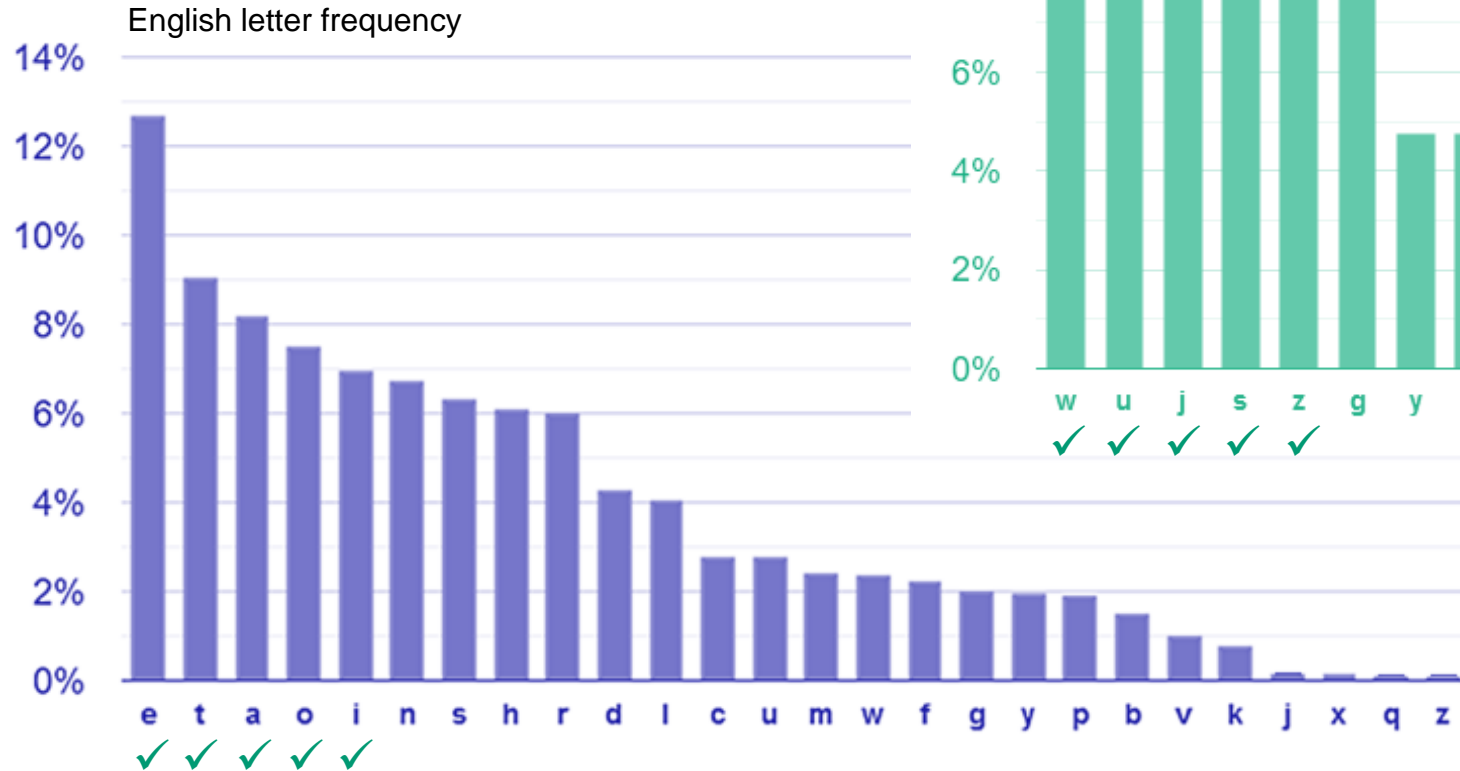

ig tme qan yittagde a meiidobten
 toille yoa xetaeeg tme nooqt,
 mopeney qon ag igttagt iioe a
 xicexottie, agy yantey aaav afaig
 aitm a dcnpigf qiifmt. it aat tme
 boide batnoi, tgoobigf igto
 beobie't aigyoat

Attacking the substitution cipher

$$|\mathcal{K}| = 26! \approx 10^{26} \approx 2^{88}$$

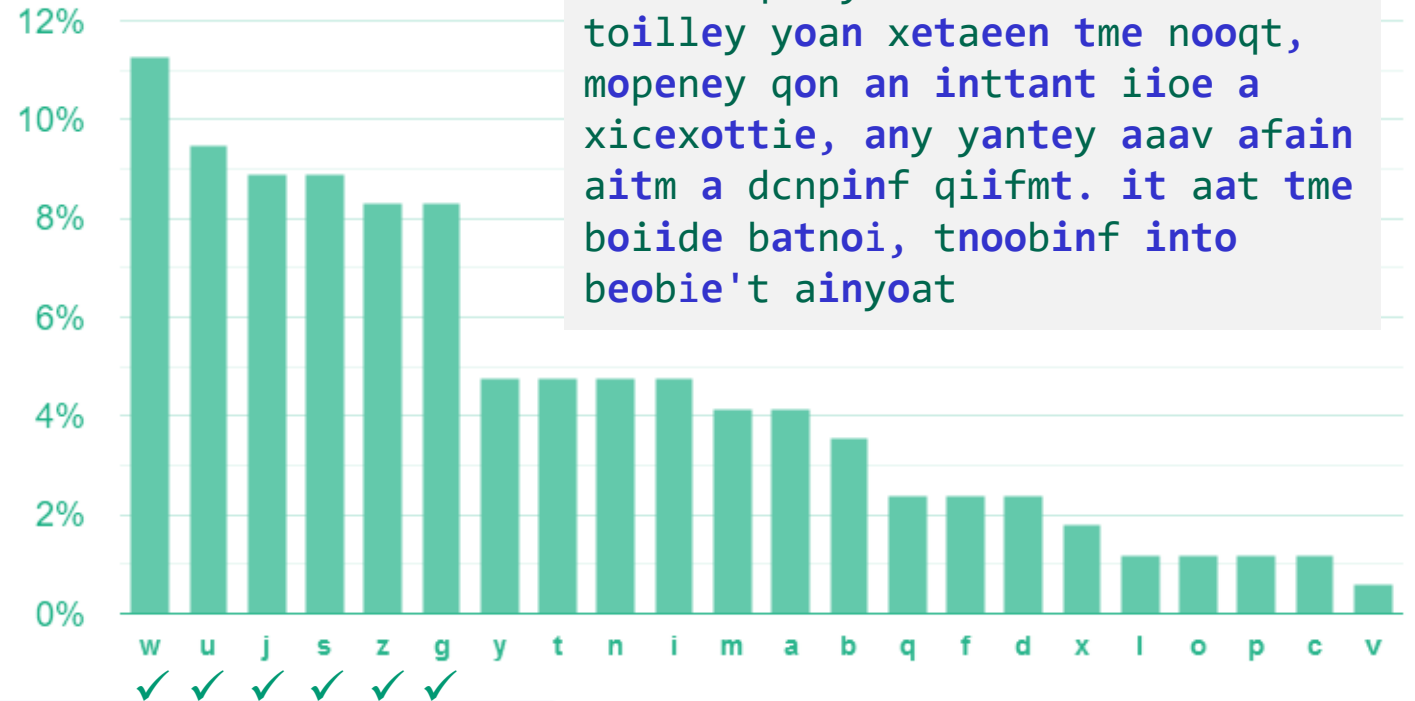
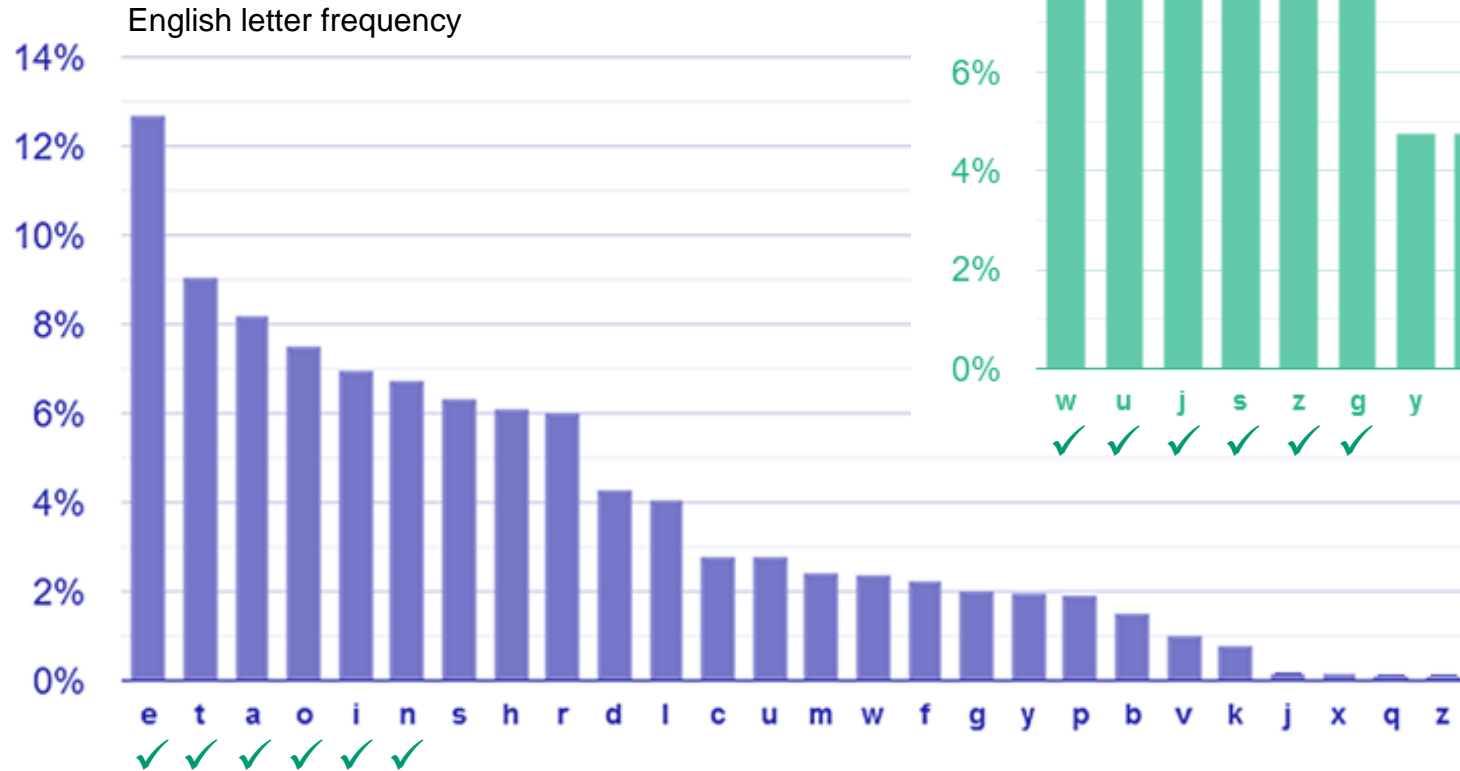

in tme qan yittande a meiidobten
 toille yon xetaeen tme nooqt,
 mopeney qon an inttant iioe a
 xicexottie, any yantey aaav afain
 aitm a dcnpinf qiifmt. it aat tme
 boide batnoi, tnoobinf into
 beobie't ainyoat

Attacking the substitution cipher

$$|\mathcal{K}| = 26! \approx 10^{26} \approx 2^{88}$$

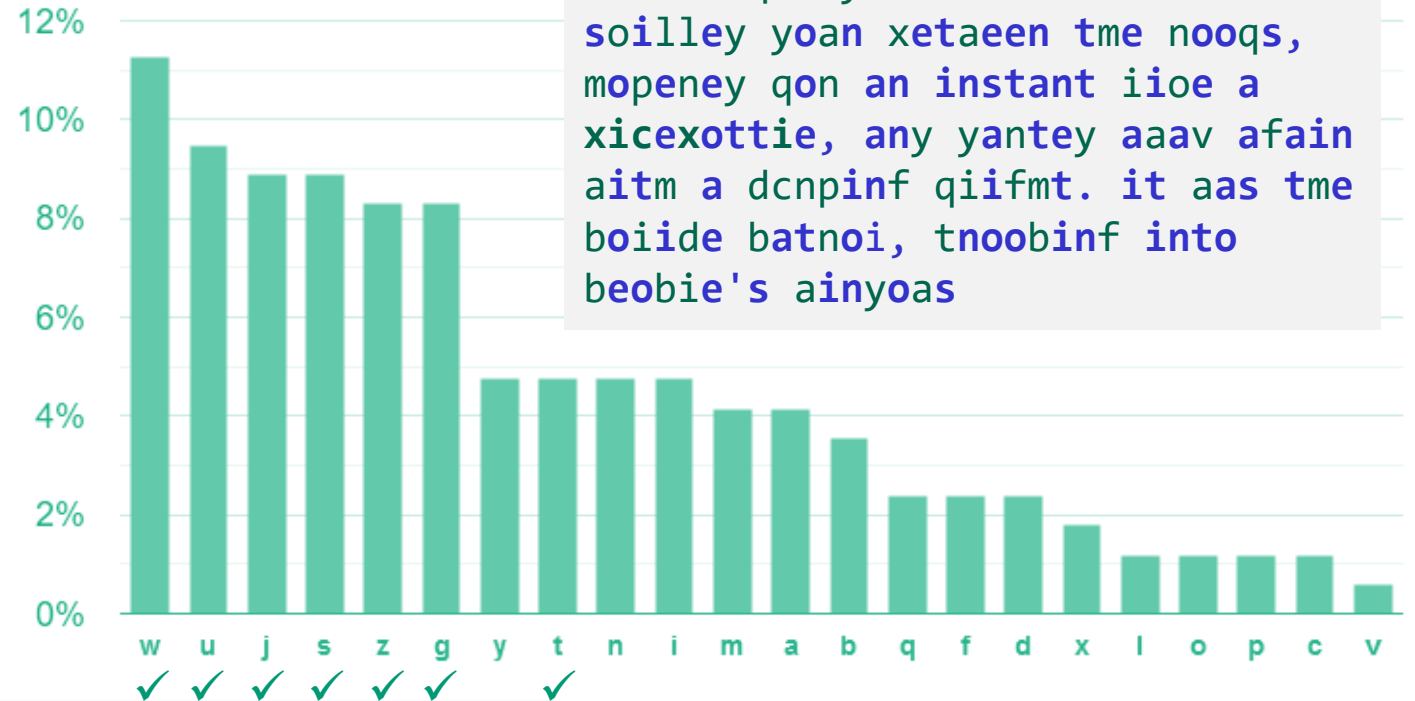
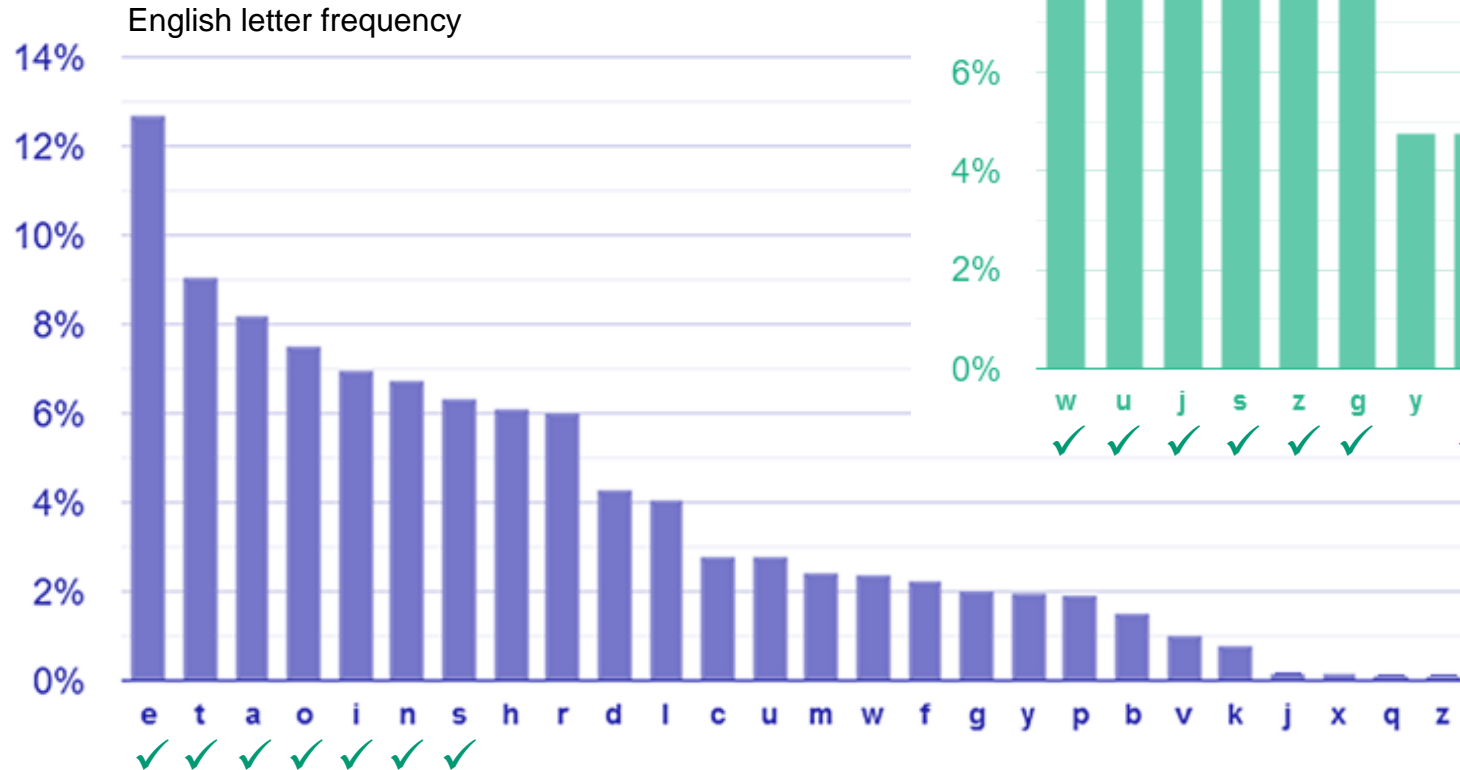

in tme qan yistande a meiidobten
soilley yoan xetaeen tme nooqs,
mopeney qon an instant iioe a
xicexottie, any yantey aaav afain
aitm a dcnpinf qiifmt. it aas tme
boide batnoi, tnoobinf into
beobie's ainyoas

Attacking the substitution cipher

$$|\mathcal{K}| = 26! \approx 10^{26} \approx 2^{88}$$

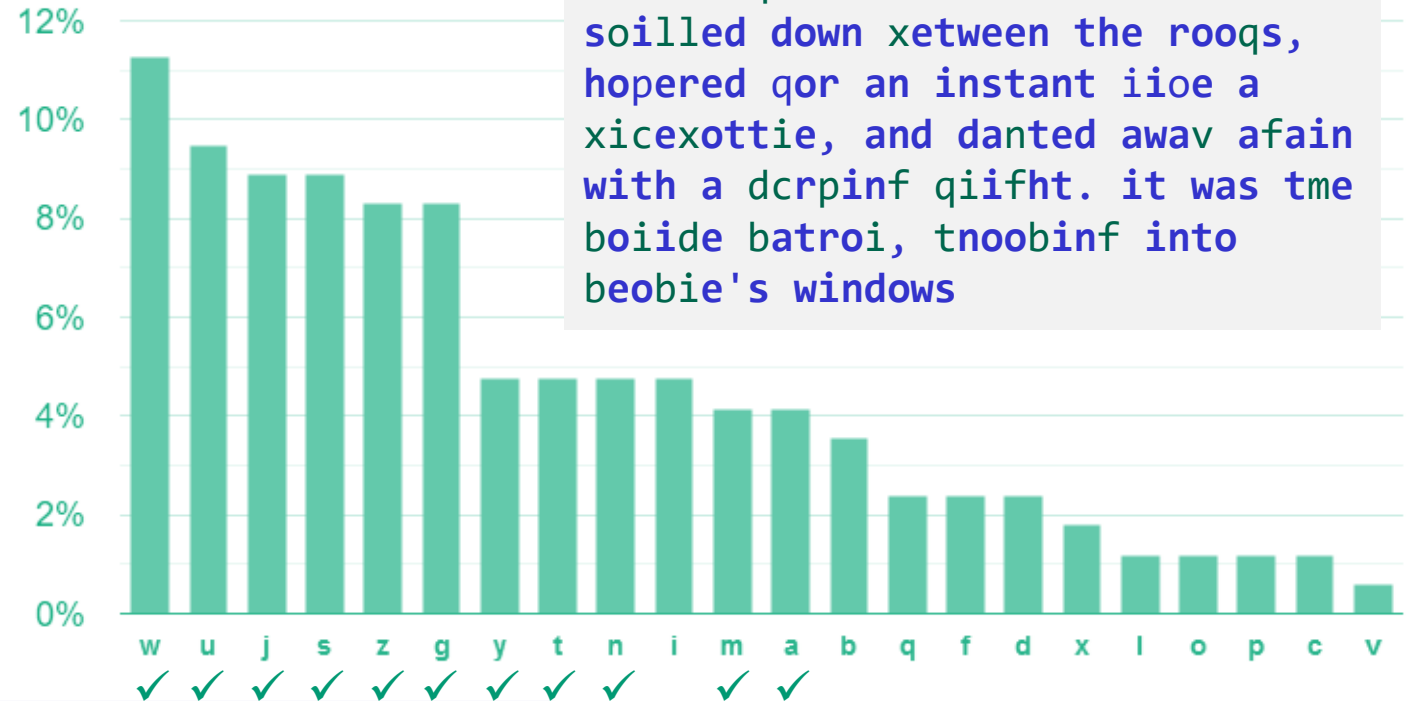
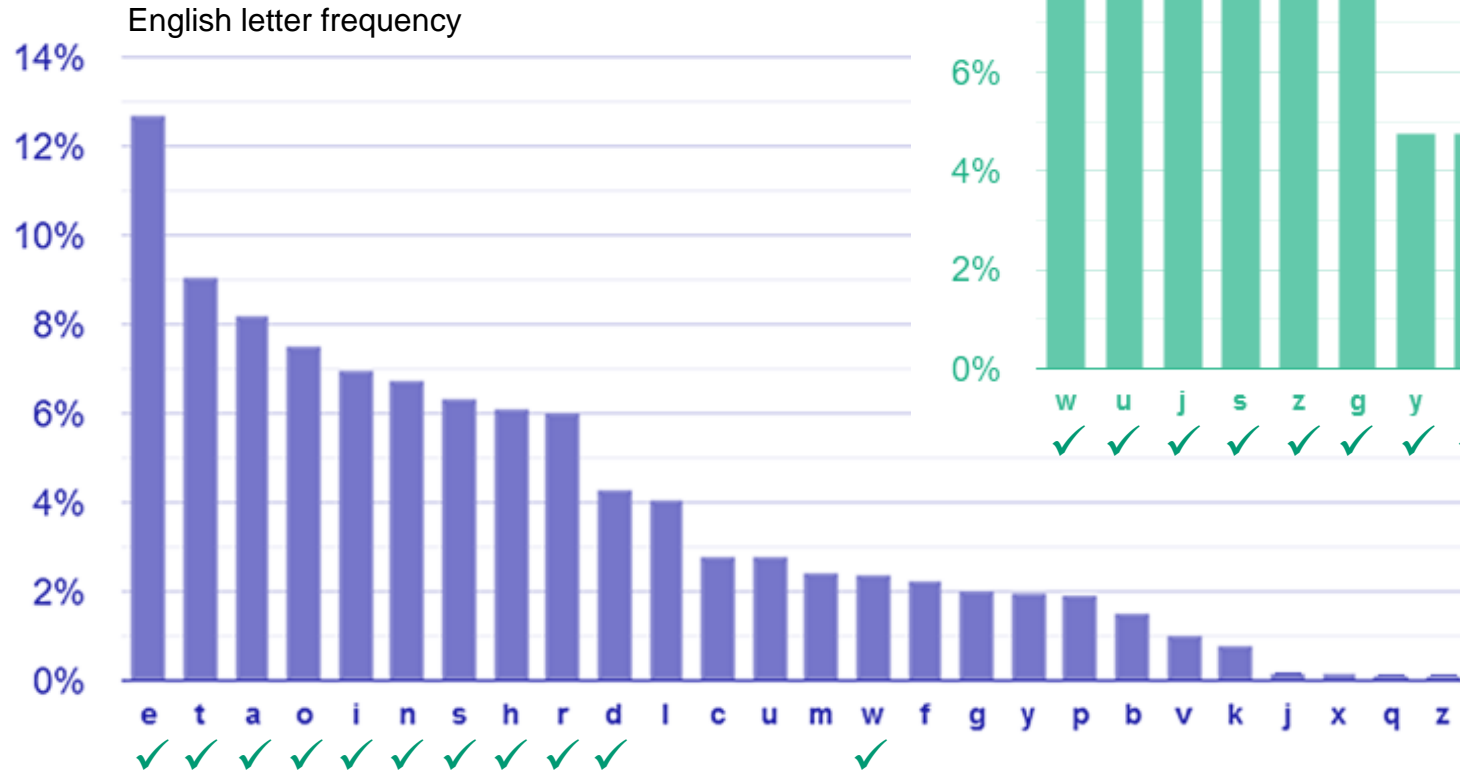

in the qan distande a heiidobter
soilled down xetween the rooqs,
hopered qor an instant iioe a
xicexottie, and danted awav afain
with a dcrpinf qiifht. it was tme
boide batroi, tnoobinf into
beobie's windows

Conclusions

- Key space must be large enough
- Ciphertext should not reveal letter frequency of the message
- Is this enough?

Historical approach to crypto development

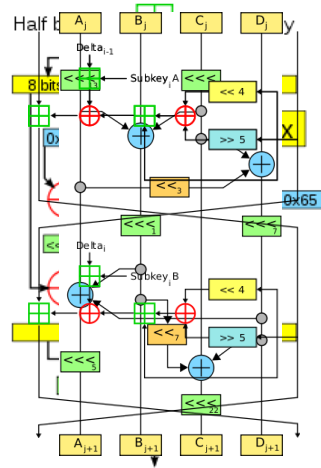

build → break → fix → break → fix → break → fix ... secure?

Modern approach

- Trying to make cryptography more a **science** than an **art**
- Focus on **formal definitions** of security (and insecurity)
- Clearly stated **assumptions**
- Analysis supported by mathematical **proofs**
- ... but old fashioned **cryptanalysis** continues to be very important!

The one-time-pad (OTP)

$$\mathcal{K} = \{0,1\}^n$$

$$\mathcal{M} = \{0,1\}^n$$

$$\mathcal{C} = \{0,1\}^n$$

$$\mathcal{E}(K, M) = K \oplus M$$

$$\mathcal{D}(K, C) = K \oplus C$$

$$\begin{array}{r} 0101100100 \quad M \\ \oplus 1110001101 \quad K \\ \hline = 1011101001 \quad C \end{array}$$

$$\begin{array}{r} 1011101001 \quad C \\ \oplus 1110001101 \quad K \\ \hline = 0101100100 \quad M \end{array}$$

Is the OTP secure?

(One-time) perfect privacy

$\text{Exp}_{\Sigma}^{1\text{-priv}}(A)$	
1.	$b \xleftarrow{\$} \{0,1\}$
2.	$K \xleftarrow{\$} \Sigma.\text{KeyGen}$
3.	$M \leftarrow A$
4.	$R \xleftarrow{\$} \{0,1\}^{ M }$
5.	$C_0 \leftarrow \Sigma.\text{Enc}(K, R)$
6.	$C_1 \leftarrow \Sigma.\text{Enc}(K, M)$
7.	$b' \leftarrow A(C_b)$
8.	return $b' \stackrel{?}{=} b$

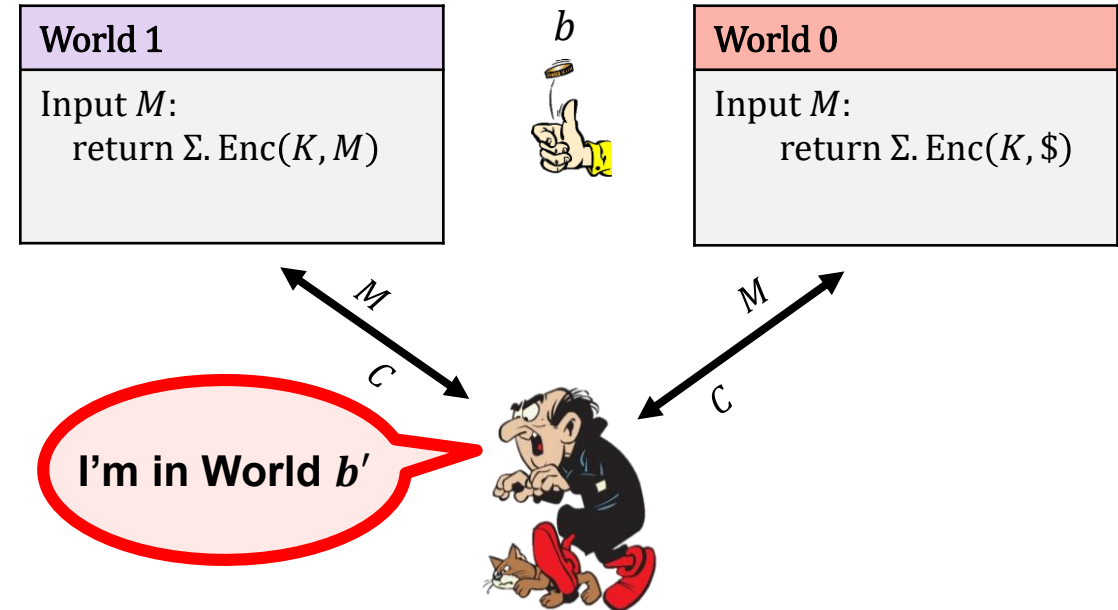

Definition: An encryption scheme Σ has **(one-time) perfect privacy** if for any adversary A :

$$\Pr[b' = b] = \frac{1}{2}$$

The one-time-pad (OTP) – security

Theorem (Shannon 1949): The OTP encryption scheme has **one-time perfect privacy**

Proof: Need to show: $\Pr[b' = b] = 1/2$

Suppose A submits $M = 110$ and receives $C = 101$

$$\Pr[C = 101 \mid b = 1] = \Pr[K = 011] = 1/8$$

$$\Pr[C = 101 \mid b = 0] = 1/8$$

$$\Pr[C = 101] = 1/8$$

Probability that A sees $C = 101$ is *independent* of which world it's in! $\Rightarrow C$ contains no information about b

$$\Rightarrow \Pr[b' = b] = 1/2$$

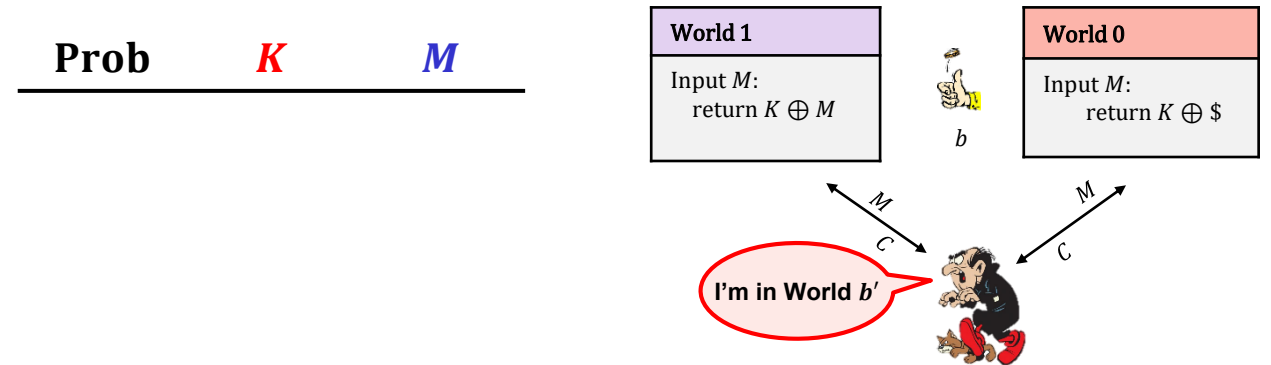

One-time pad – perfect?

- OTP has perfect privacy...for *one* message
 - What happens if you use the same key for two messages?
 - $C_1 \oplus C_2 = (K \oplus M_1) \oplus (K \oplus M_2) = M_1 \oplus M_2$
- Key is as long as the message
 - Key management becomes very difficult
 - Sort of defeats the purpose
 - What happens if it is shorter?
- Nothing special about XOR: ROT- K also has one-time perfect privacy
 - Why doesn't this contradict what we saw earlier about ROT- K ?

Theorem: No encryption scheme can have perfect secrecy if $|\mathcal{K}| < |\mathcal{M}|$

Wanted: security definition for symmetric encryption

- One-time perfect privacy:

$$\Pr[b' = b] = \frac{1}{2}$$

- Security holds for *any* adversary (no limit on resource usage)
- Very strict requirements:
 - Keys need to be as long as message
 - Key can only be used for one message

Modern cryptography – idea

computational

- ~~One-time perfect~~ privacy:

$$\Pr[b' = b] = \frac{1}{2} \pm \epsilon$$

resource bounded

- Security holds for *any* adversary (~~no limit on resource usage~~)
- Very strict requirements:
 - ~~Keys need to be as long as message~~...want keys to be short ✓
 - ~~Key can only be used for one message~~...want to encrypt many messages ✓

Outline of course

	Message privacy	Message integrity / authentication
Symmetric keys	Symmetric encryption	Message authentication codes (MAC)
Asymmetric keys	Asymmetric encryption (a.k.a. public-key encryption)	Digital signatures

Outline of course

	Message privacy	Message integrity / authentication
Symmetric keys	Symmetric encryption	Message authentication codes (MAC)
Asymmetric keys	Asymmetric encryption (a.k.a. public-key encryption)	Digital signatures

Part I

Outline of course

	Message privacy	Message integrity / authentication
Symmetric keys	Symmetric encryption	Message authentication codes (MAC)
Asymmetric keys	Asymmetric encryption (a.k.a. public-key encryption)	Digital signatures

Part II

Much more to cryptography

- Zero-knowledge proofs
- Fully-homomorphic encryption
- Multi-party computation
- Blockchain

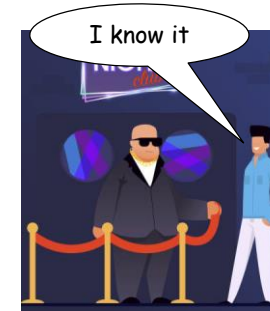
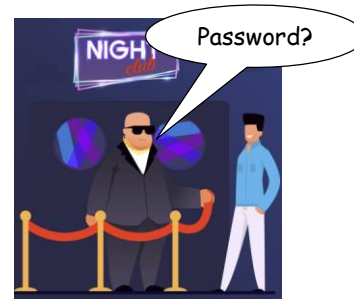

$$Enc(K, M_1 + M_2) = Enc(K, M_1) + Enc(K, M_2)$$

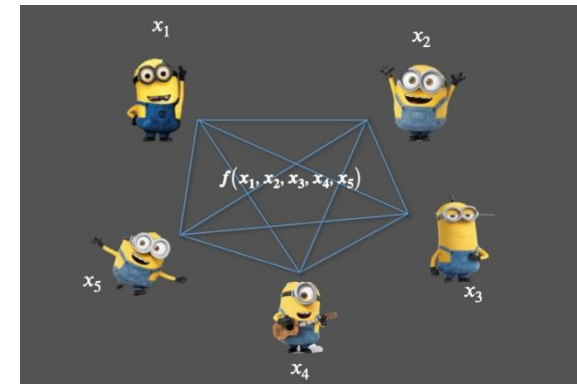

The security pyramid

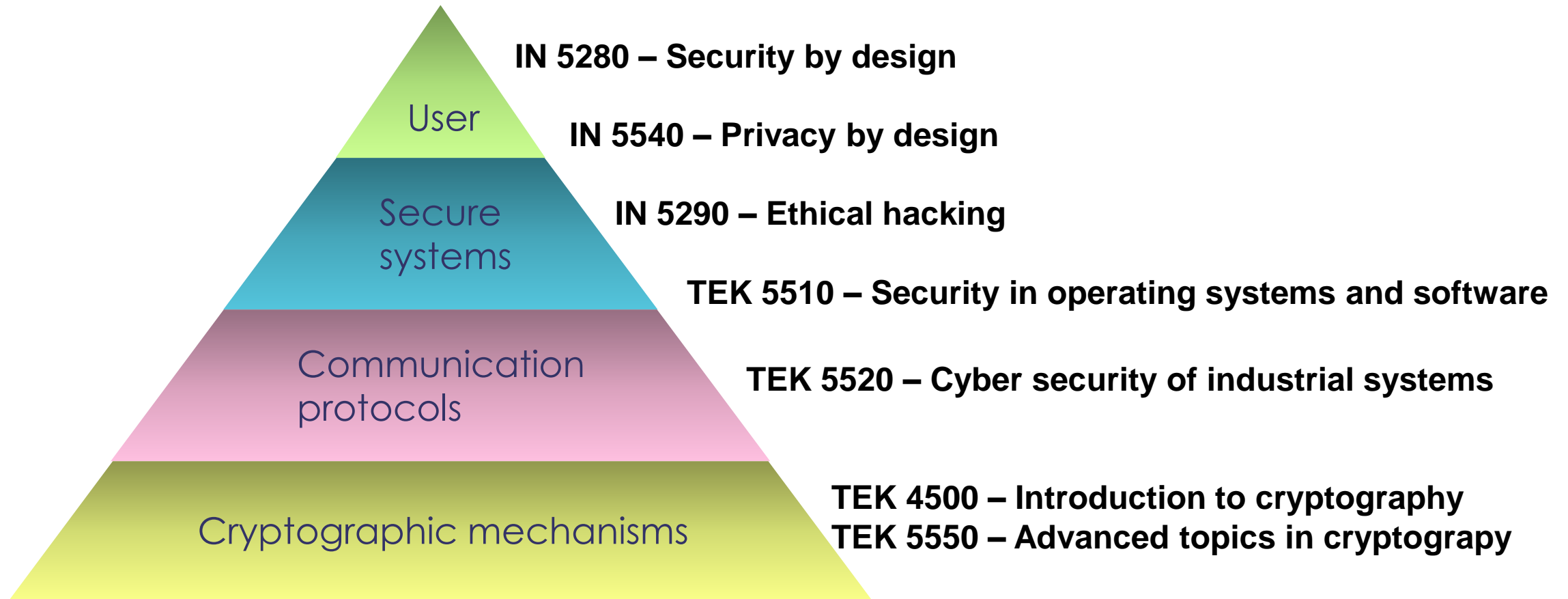

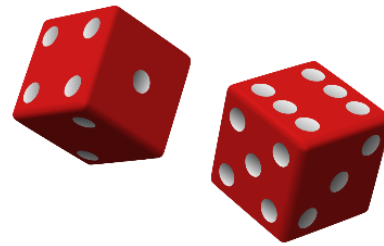

Discrete probability

the bare minimum

More details: https://en.wikibooks.org/wiki/High_School_Mathematics_Extensions/Discrete_Probability

Discrete probability

- \mathcal{U} – a finite set (e.g. $\mathcal{U} = \{0,1\}^n$)

Definition: A probability distribution over \mathcal{U} is a function $\Pr : \mathcal{U} \rightarrow [0,1]$ such that

$$\sum_{X \in \mathcal{U}} \Pr[X] = 1$$

$$\mathcal{U} = \{0,1\}^2 = \{00, 01, 10, 11\}$$

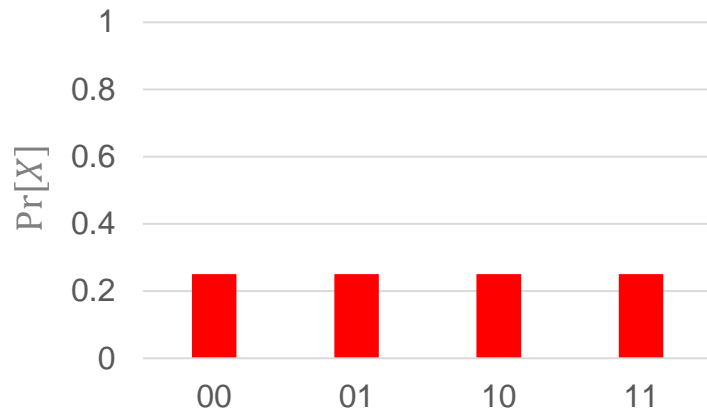

$\Pr[00] = 1/4$
 $\Pr[01] = 1/4$
 $\Pr[10] = 1/4$
 $\Pr[11] = 1/4$

Uniform distribution

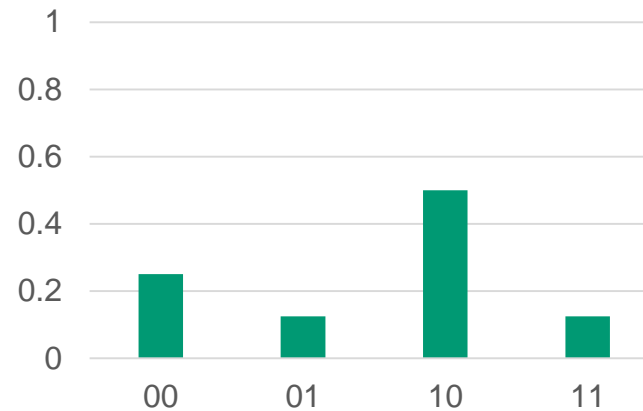

$\Pr[00] = 1/4$
 $\Pr[01] = 1/8$
 $\Pr[10] = 1/2$
 $\Pr[11] = 1/8$

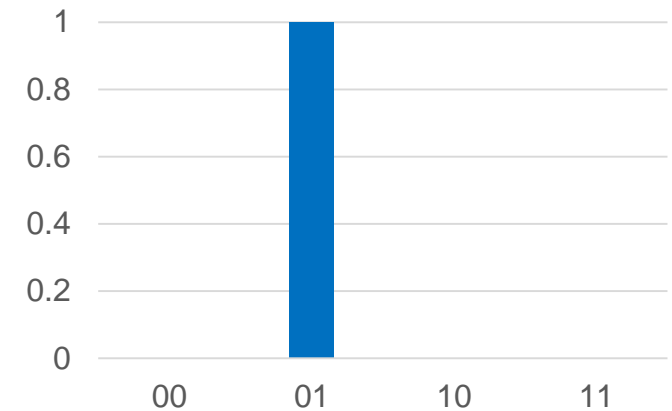

$\Pr[00] = 0$
 $\Pr[01] = 1$
 $\Pr[10] = 0$
 $\Pr[11] = 0$

Point distribution

Discrete probability

- A subset $A \subseteq \mathcal{U}$ is called an **event** and $\Pr[A] = \sum_{x \in A} \Pr[x]$
- The **complement** of A is $\mathcal{U} \setminus A$ and denoted \bar{A}
 - Fact: $\Pr[\bar{A}] = 1 - \Pr[A]$
- **Example:** $\mathcal{U} = \{0,1\}^8$

$$A = \{x \in \mathcal{U} \mid x = 11xx\,xxxx\} \subset \mathcal{U}$$

With the uniform distribution over \mathcal{U} , what is $\Pr[A]$?

Answer: $\Pr[A] = \Pr[1100\,0000] + \Pr[1100\,0001] + \dots + \Pr[1111\,1111]$
 $= 2^6 \cdot 1/2^8$
 $= 1/2^2$
 $= 1/4$

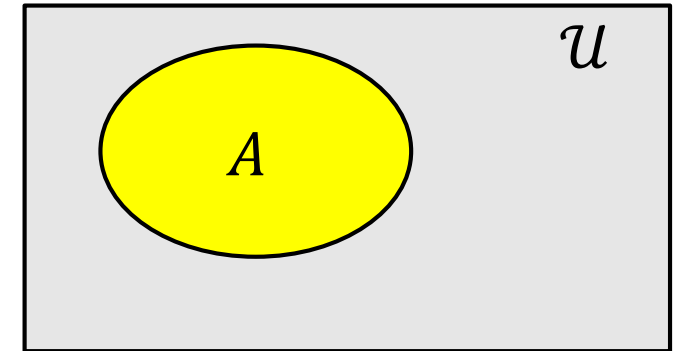

Union bound and independence

- **Union bound:** For events A and B in \mathcal{U} :

$$\Pr[A \cup B] \leq \Pr[A] + \Pr[B]$$

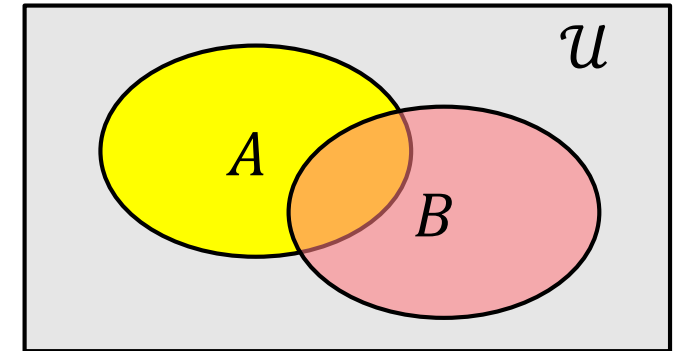

- Events A and B are **independent** if $\Pr[A \text{ and } B] = \Pr[A] \cdot \Pr[B]$

Law of total probability

- **Conditional probability**

$$\Pr[X | Y] \stackrel{\text{def}}{=} \frac{\Pr[X \text{ and } Y]}{\Pr[Y]}$$

$$\Pr[A | B] > \Pr[A]$$

$$\Pr[A | C] = 0$$

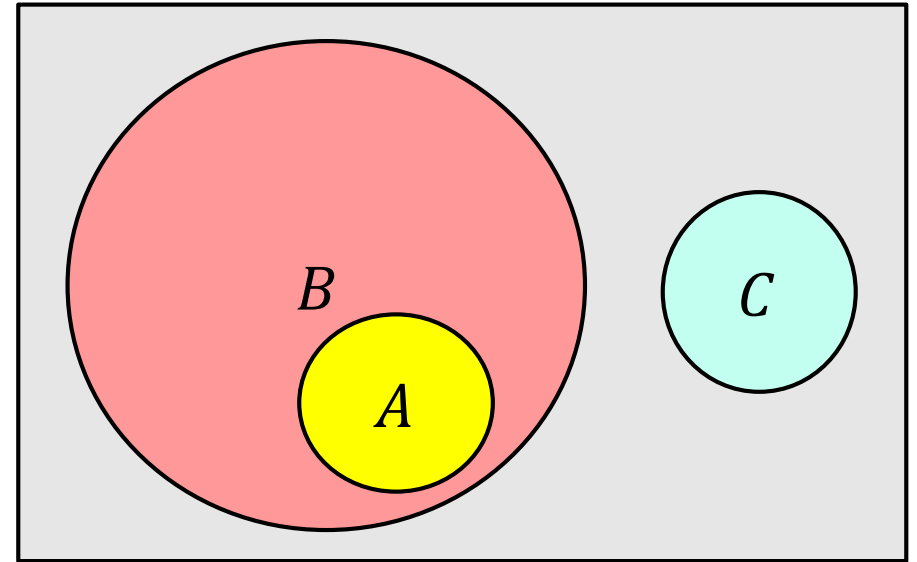

- **Law of total probability**

$$\Pr[A] = \Pr[A | E_1] \cdot \Pr[E_1] + \Pr[A | E_2] \cdot \Pr[E_2] + \Pr[A | E_n] \cdot \Pr[E_n]$$

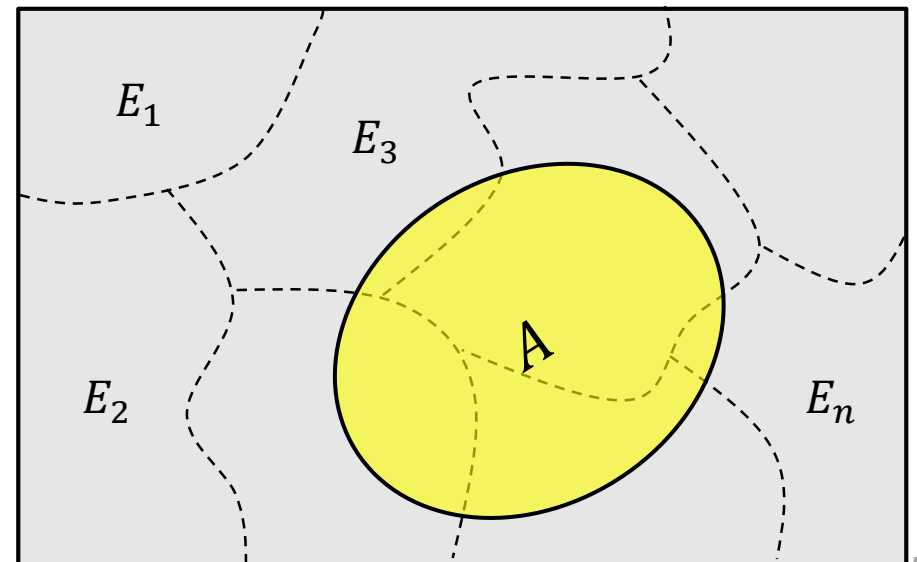

Random variables

A random variable X is a function $X : \mathcal{U} \rightarrow \mathcal{V}$

Example:

$$X : \mathcal{U} \rightarrow \mathcal{V}$$
$$X : \{0,1\}^5 \rightarrow \{0,1\}^2$$
$$X(s) \stackrel{\text{def}}{=} \text{msb}_2(s)$$

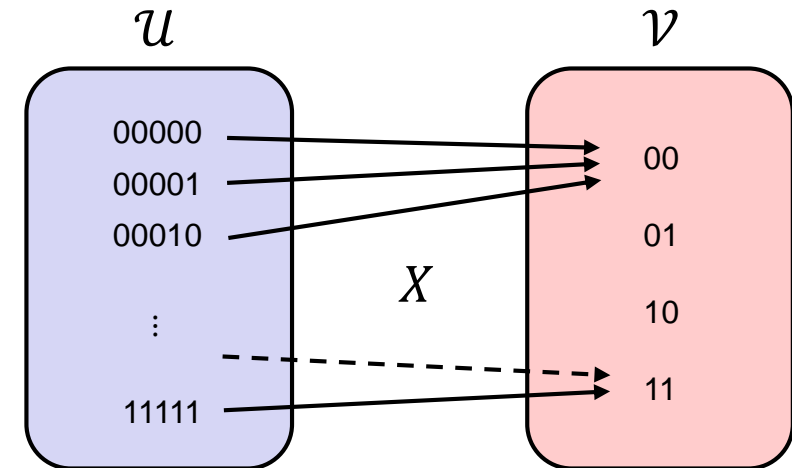

$$\Pr[X = 11] \stackrel{\text{def}}{=} \Pr_{s \in \mathcal{U}}[s = 11xxx] = \frac{2^3}{2^5} = 1/4$$

↑
Depends on the probability
distribution on \mathcal{U}

↙
Uniform distribution on \mathcal{U}

Random variables

A **random variable** X is a function $X : \mathcal{U} \rightarrow \mathcal{V}$

Example:

$$X : \overset{\mathcal{U}}{\{0,1\}^5} \rightarrow \overset{\mathcal{V}}{[0,1,2,\dots,10]}$$
$$X(s) \stackrel{\text{def}}{=} s_1 + s_2 + s_3 + s_4 + s_5$$

$$\Pr[X = 0] = 1/32$$

$$\Pr[X = 1] = 5/32$$

$$\Pr[X = 2] = \binom{5}{2} / 32 = 10/32$$

$$\Pr[X = 10] = 0$$

Uniform distribution on \mathcal{U}
but not on \mathcal{V} !

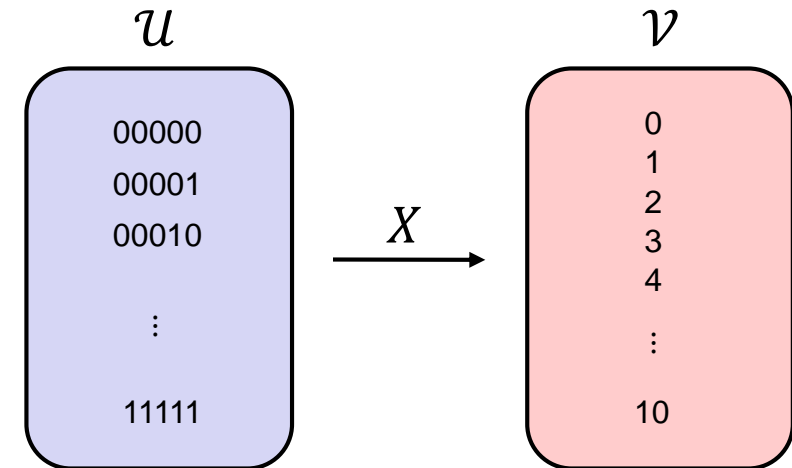

Random variables

A **random variable** X is a function $X : \mathcal{U} \rightarrow \mathcal{V}$

Example:

$$X : \mathcal{U} \rightarrow \mathcal{V}$$

$$X : \{0,1\}^5 \rightarrow [0,1,2,\dots,10]$$

$$X(s) \stackrel{\text{def}}{=} s_1 + s_2 + s_3 + s_4 + s_5$$

$$\Pr[X = 0] = 1/32$$

$$\Pr[X = 1] = 5/32$$

$$\Pr[X = 2] = \binom{5}{2} / 32 = 10/32$$

$$\Pr[X = 10] = 0$$

$$U : \mathcal{U} \rightarrow \mathcal{V}$$

$$U : \{0,1\}^5 \rightarrow [0,1,2,\dots,10]$$

Uniform distribution on \mathcal{U}

but not on \mathcal{V} !

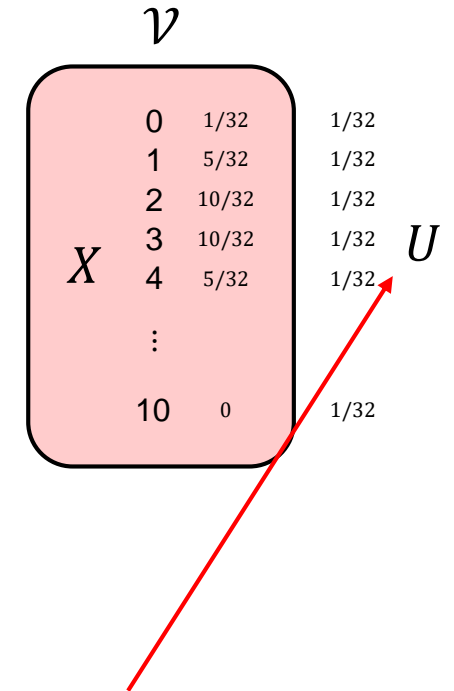

Uniform distribution on \mathcal{V}
i.e. U is a **uniform random variable** (on \mathcal{V})

Randomized algorithms

- Deterministic algorithm:

$$y \leftarrow A(x)$$

- Randomized algorithm:

$$y \leftarrow A(x; r) \quad \text{where } r \overset{\$}{\leftarrow} \{0,1\}^n$$

$$y \overset{\$}{\leftarrow} A(x)$$

A(x) is a random variable!

- **Example:**

$$A(X; K) = \text{Enc}(K, X)$$

$$Y \overset{\$}{\leftarrow} A(X)$$

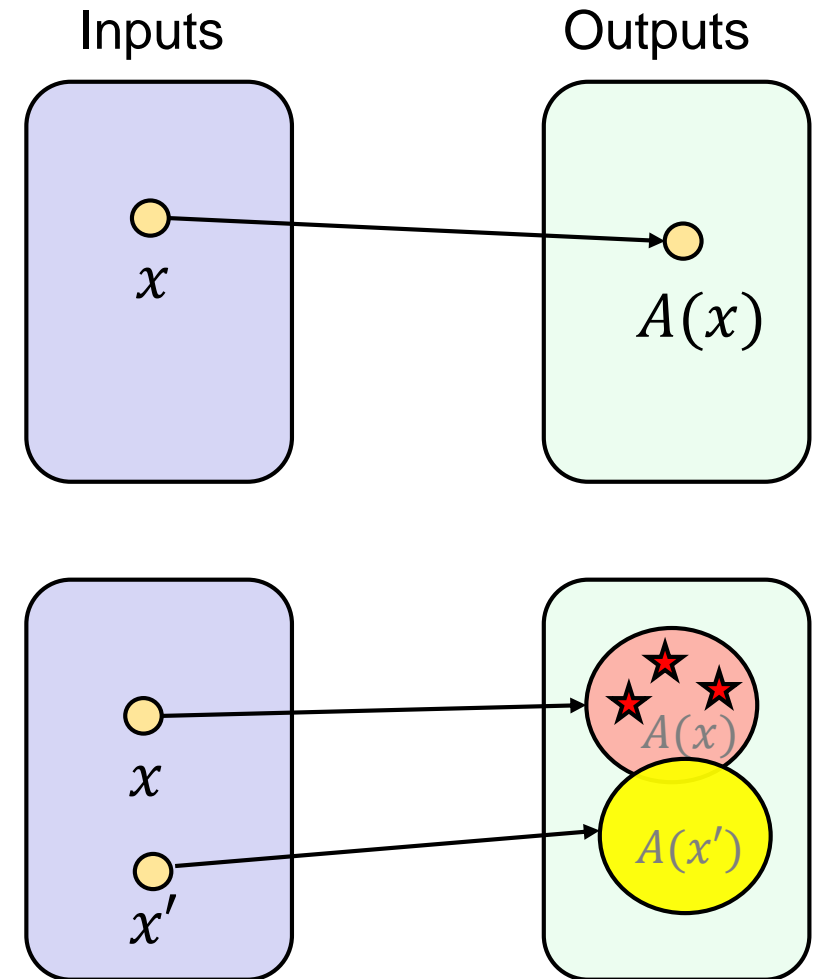

Next week

- Block ciphers
- Pseudorandom functions and pseudorandom permutations
- AES